

PantoRouter

How-To Guide

**Mortise & Tenon, Box Joints
Dovetails, and Much More!**

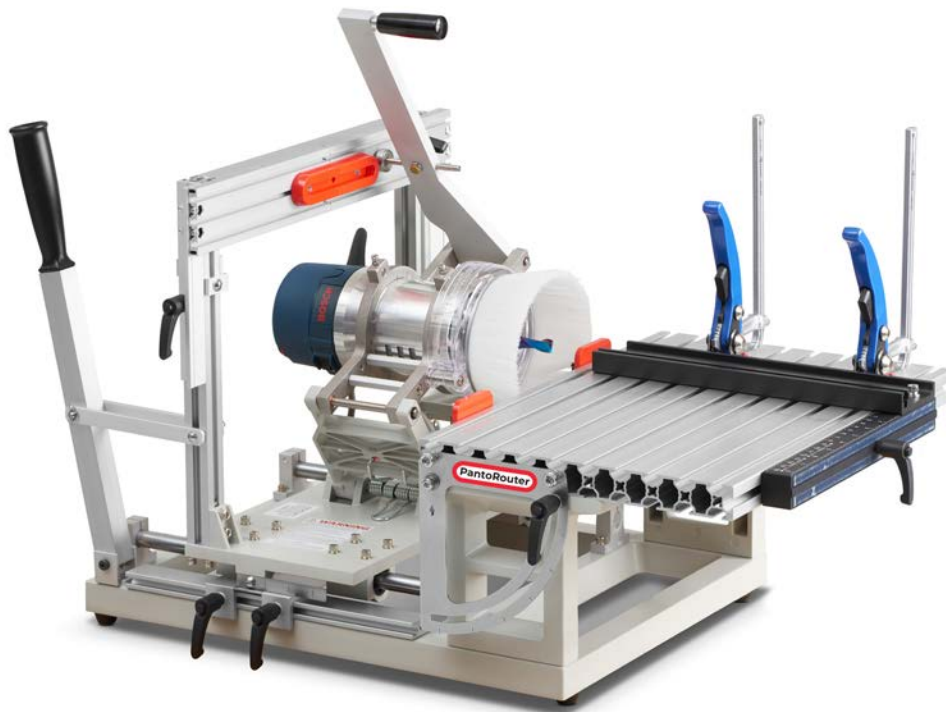

Manufactured and Distributed by
WoodCraft Solutions LLC
www.PantoRouter.com
Info@PantoRouter.com
+1-877-333-7150

Copyright January 2023 - WoodCraft Solutions LLC

SAFETY:

Woodworking is inherently dangerous. There are hazards inherent to using the PantoRouter® and many other tools in the shop, whether operated by hand or electric power. Some of these hazards are discussed below. Use common sense when operating the PantoRouter® and all woodworking tools, and use this tool in accordance with the instructions. **YOU ARE RESPONSIBLE FOR YOUR OWN SAFETY.**

Read and understand the Assembly Guide, the How-To Guide and the Warning Label on the PantoRouter®. Failure to follow instructions or heed warnings may result in electric shock, fire, serious personal injury or property damage. Save these instructions and refer to them whenever necessary.

Warning: This product can expose you to chemicals including wood dust, which is known to the State of California to cause cancer. The exposure can come from drilling, sawing, sanding or machining wood products. For more information go to www.P65Warnings.ca.gov/wood. In addition, some types of dust created by sawing, sanding, grinding, milling, drilling and other construction and woodworking activities also contain chemicals known to cause cancer, birth defects or other reproductive harm. In addition, wood dust has been listed as a known human carcinogen by the U.S. Government. The risk from exposure to these chemicals and to dust varies depending on how often you do this type of work. To reduce your exposure, work in a well ventilated area and work with approved safety equipment including dust collection, properly fitted dust masks or respirators designed to filter out such dust and chemicals.



YOU ARE RESPONSIBLE FOR YOUR OWN SAFETY.

TO REDUCE THE RISK OF INJURY, THE USER MUST:

- READ AND UNDERSTAND THE OPERATING GUIDES BEFORE OPERATING PRODUCT.
- WEAR EYE PROTECTION, EARPLUGS AND DUST MASK.
- DO NOT WEAR GLOVES, NECKTIES, JEWELRY OR LOOSE CLOTHING. CONTAIN LONG HAIR.
- KNOW HOW TO SHUT OFF ROUTER IN AN EMERGENCY.
- DISCONNECT ROUTER FROM POWER SOURCE BEFORE SERVICING OR CHANGING ROUTER BIT.
- DO NOT ADJUST THE ROUTER UNTIL IT HAS BEEN DISCONNECTED FROM POWER.
- SECURELY MOUNT THE ROUTER IN MOUNTING BRACKET BEFORE TURNING POWER ON. IF ROUTER MOTOR CANNOT BE SECURELY MOUNTED AS DESCRIBED IN THE ASSEMBLY INSTRUCTIONS, DO NOT USE THE PANTOROUTER®. CHECK ROUTER MOUNT SECURITY PRIOR TO EACH OPERATION.
- CLAMP MATERIAL TO BE CUT SECURELY TO TABLE BEFORE STARTING ROUTER.
- NEVER USE A BIT NOT SPECIFICALLY DESIGNED FOR USE IN A WOODWORKING ROUTER.
- KEEP HANDS AND CLOTHING AWAY FROM SPINNING ROUTER BIT.
- DO NOT OPERATE THIS MACHINE WHILE UNDER THE INFLUENCE OF ALCOHOL OR DRUGS.
- WHEN SERVICING, USE ONLY IDENTICAL PARTS.
- FAILURE TO COMPLY WITH THESE WARNINGS MAY RESULT IN SERIOUS PERSONAL INJURY

TABLE OF CONTENTS

SAFETY	2
<hr/>	
MORTISE AND TENON JOINERY	4
<hr/>	
Terminology	5
Mortise and tenon Template Systems	6
Essential Mortise and Tenon Template selection	7
Cutting a mortise and tenon joint	8
Segmented Mortise and Tenon Template set	18
Slot Mortise and Tenon Template set	20
Floating tenons and bridle joints	22
<hr/>	
DOVETAILS ON THE PANTOROUTER®	23
<hr/>	
Setting up and cutting dovetails	24
Tips for successful dovetails	30
<hr/>	
BOX JOINTS	33
<hr/>	
DOWEL TEMPLATES	37
<hr/>	
SPECIALTY TEMPLATES	41
<hr/>	
CALIBRATING THE TEMPLATE HOLDER	42
<hr/>	
REFERENCE MATERIALS AND VIDEO LINKS	43
<hr/>	

Mortise and Tenon Overview

Mortise and tenon joinery is a time-tested traditional joinery method that has been around for roughly 7,000 years! This strong and elegant joint allows craftspeople and woodworkers to join pieces together without the need for metal fasteners. While there are many ways to cut mortise and tenon joints, the PantoRouter® offers a repeatable and accurate solution to creating both sides of the joint using a single template.



Anatomy and Terminology of a Mortise and Tenon Joint

Mortise

Tenon

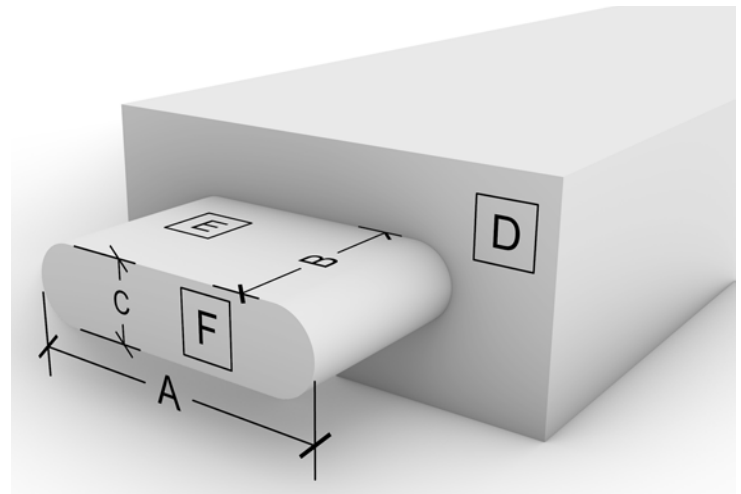
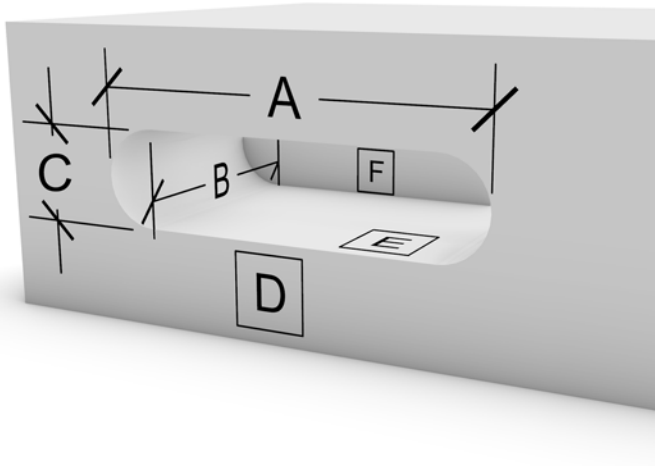

- A. Mortise Width
- B. Mortise Depth
- C. Mortise Thickness
- D. Face
- E. Mortise Wall
- F. Bottom

- A. Tenon Width
- B. Tenon Length
- C. Tenon Thickness
- D. Shoulder
- E. Tenon cheek
- F. End

General guidelines and ratios

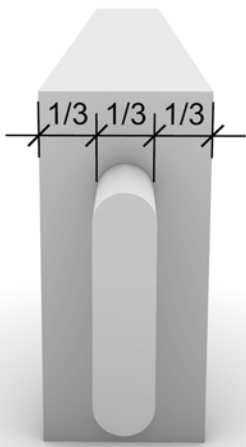

Ideal shoulder size equal to tenon thickness

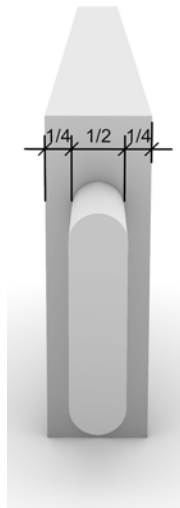

Minimum shoulder size 1/2 of tenon thickness

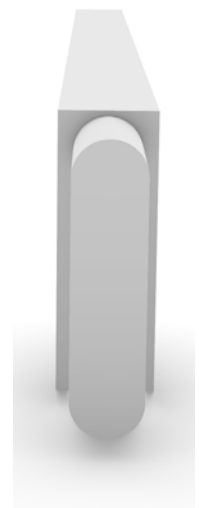

Very narrow shoulder Not recommended

Mortise and tenon template systems

Over the years, we have developed several template systems to cut mortise and tenon joints, each with their appropriate applications. This section will cover each template system, their advantages, and how to select the correct template system for any given project.

Essential mortise and tenon set

Page: 7

The Essential Mortise and Tenon set is comprised of five horizontal and two vertical templates all labeled with an identifying letter and their finished cut size. This set is a great option to go from set-up to glue-up in a matter of minutes for standard sizes of mortise and tenon joints.



Segmented mortise and tenon set

Page: 18

The segmented template set gives the widest variety of size options for mortise and tenon joinery. With 154 sizes of mortise and tenons to choose from and an additional 77 sizes of tenons with square ends, this system allows you to choose the perfect size for your project.



Slot mortise set

Page: 20

This set is for mortising only, no tenons are cut with these templates. This is a great option for cutting any size mortise for slip tenons, finger holds, bridle joints, and much more!



Specialty Mortise and tenon templates

Page: 41

Specialty templates combine decorative details and incredibly strong joinery. They can be modified and embellished to give a truly unique look as seen later in this How-To Guide.



Matching mortise and tenons in minutes

With its 2-to-1 movement and 2-in-1 templates, the PantoRouter® woodworking machine makes faster, better-fitting mortises and tenons than any other method. The templates are the key, capturing the guide bearing in the center mortise slot to make the mortise, then tracing the guide bearing around the outside of the template for foolproof tenons. The tapered perimeter guide surface of the template allows fine adjustments to tenon fit for perfect results right off the machine.

The Standard PantoRouter® Package includes an array of templates for various joint sizes and orientations, the Pro-Pack and All-In Packages have even more, and all are available à la carte from our on-line store.

The genius of the system doesn't stop at the templates. Setting up the template holder, fences and depth stop is just as fast and easy. And, once they are set, you can make stacks of joints in minutes, dead-accurate and dust-free thanks to our patent dust-collection attachment.

Follow the process shown here, and you'll make better joints than ever before, in a fraction of the time.

Set-up steps for Essential M&T Templates

Choose your template. The thickness of your mortise is determined by the size of the router bit used to cut them. By changing the bit and guide bearing, you can make the corresponding tenon, so all that matters here is width (the 2-to-1 pantograph ratio means joints are always half the width of a given template).

All templates have tabs on the back to keep them aligned with the template holder, and small nuts that slide into T-slots. The templates marked B-V and D-V have tabs on the back that are perpendicular to the template so they hold the template in a vertical position. The Essential Templates are "optimized for 1/2" mortise and tenon. This means when using a 1/2" bit for the mortise, the width will be the size printed on the template. When using a smaller bit, the mortise will be narrower and when using a bit larger than 1/2", the mortise width will be wider than the size printed on the template. For a thorough explanation of this and exact sizes when mortising with bits other than 1/2", please refer to the chart at the bottom of page 13.

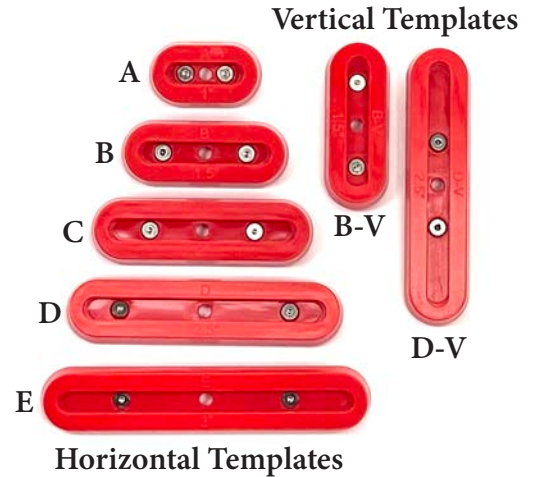

Center the template side to side. Insert a 6mm (~1/4") round, non-tapered guide bearing shaft through the template and through the center hole in the template holder. That's all there is to it! Your template is now centered.

Note: Older template holders don't have the centering hole so the pointed centering jig is used in the router to center the template. You can get more information about this process by reading our How-to guide for 2017 models & older at: www.pantorouter.com/getting-started/#how-to-guides



Center the template vertically. This step is just as easy. Once you've properly set the thickness gauge below the template holder (see the Assembly Guide set-up instructions for the PantoRouter®), place a cutoff from your workpiece, or the workpiece itself, between the template holder and thickness gauge to center the template and router bit on the stock. Lock the template holder in that position.

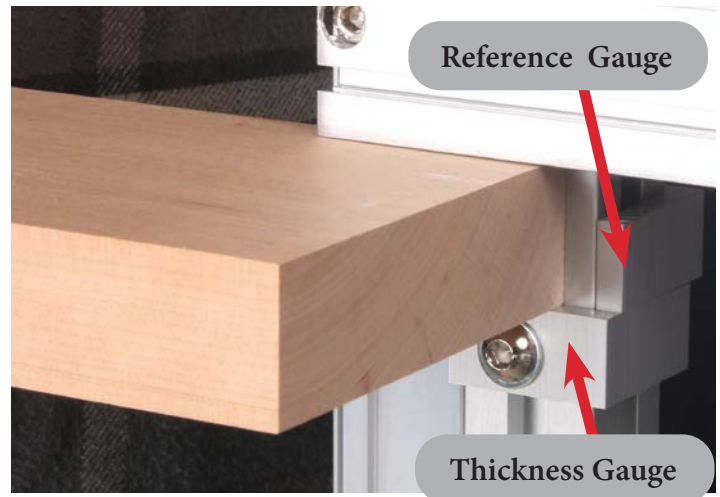

Note: To accurately center the template vertically on your work piece, it is important that the wood is not skewed or tilted when placed between the thickness gauge and the template holder. When the workpiece is held firmly between those two points, tighten both template holder locking lever knobs prior to making a cut.



Example mortise and tenon joint.

For this simple example, our stock is 3" wide and 1-1/4" thick. The two identical workpieces are joined at a 90 degree angle, flush on both faces as well as the edge as seen below.

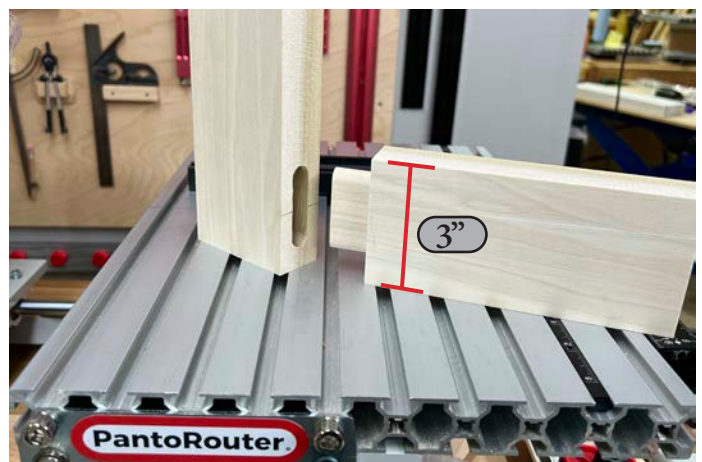

The height of the template has already been set to be centered vertically in the thickness of our workpiece so the next step is to set the Centering Scale Fence at the correct location on the table so the tenon falls in the center of the 3" piece of wood.

The tenon workpiece is used to set the fence even though we always cut our mortises first. When cutting a mortise and tenon joint where the two pieces are flush on top, the center of the mortise is the same distance from the reference edge as our tenon. Set the fence so the centerline of the tenon piece aligns with the centerline on the table. In this case, with a 3" wide workpiece, the centerline of the tenon is 1½" from the reference edge of the workpiece therefore the fence will be set 1½" from the centerline of the table.

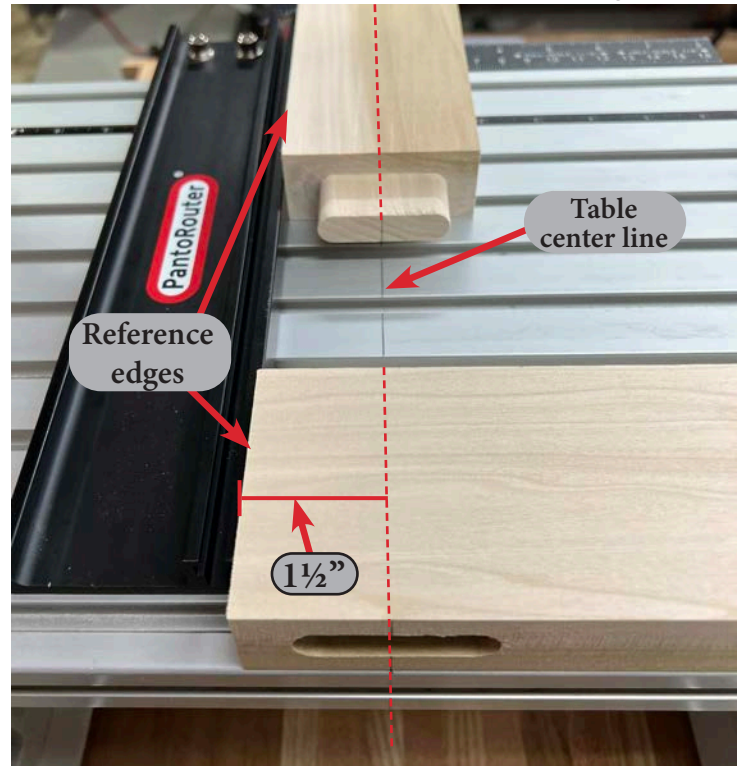
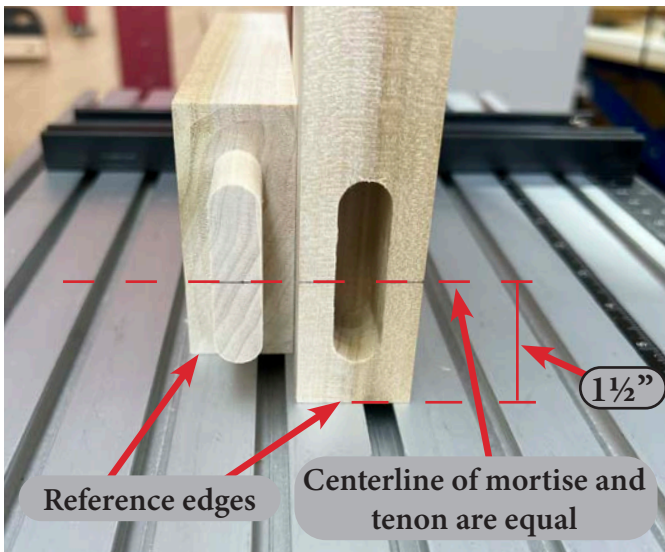

Setting the Centering Scale Fence. To set the fence in the correct location on the table, simply measure the width of your workpiece using the full scale ruler on the fence and align the corresponding measurement on the 1/2-scale ruler to the center line of the table. In this example with our 3" wide workpiece, you can see the "3" mark on the 1/2-scale ruler is aligned with the centerline of the table.

The Centering Bar can also be used with the split shaft centering jig that came with your machine as a pointer to indicate the location of the fence relative to the centerline of the table. In this case, the split-shaft centering jig is pointing at the 1½" mark on the centering bar. To accurately locate the centering scale fence on the table.

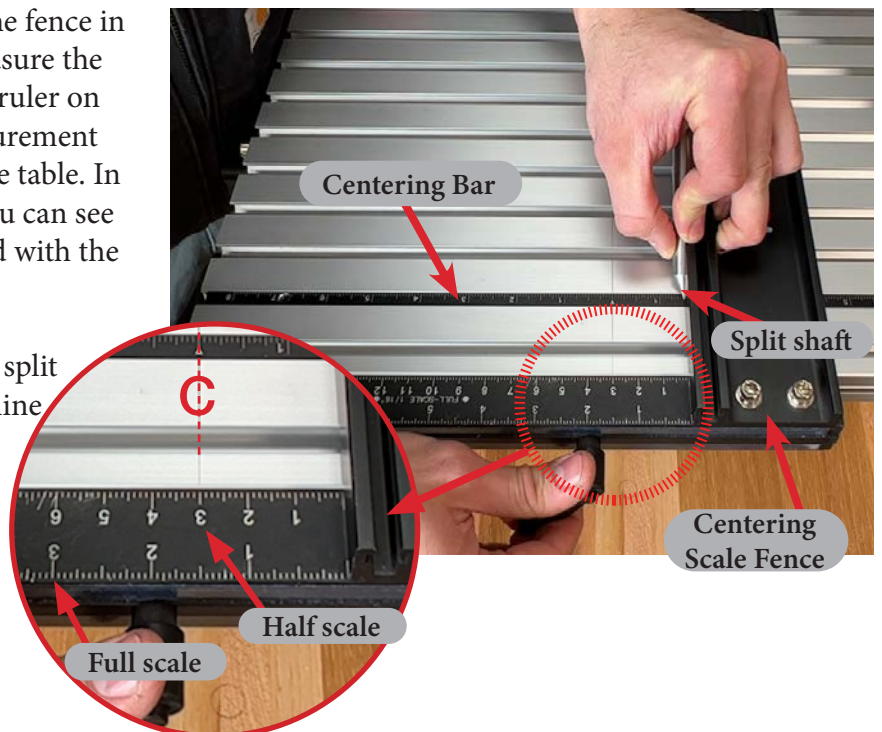

Tip: to confirm your workpiece is perfectly centered, place your workpiece on the table against the centering scale fence. Transfer the centerline from the table to your workpiece and extend that line from one face to the other. Now, flip your workpiece 180 degrees and your pencil line should remain on the centerline of the table regardless of which face is up. If they do not both align to the centerline, your workpiece is not centered.



Mortises first

Insert the mortise guide bearing. Choose the 10mm (~3/8") guide bearing and insert it into the mortise slot of the template. Also, insert the bit for the mortise you are cutting.

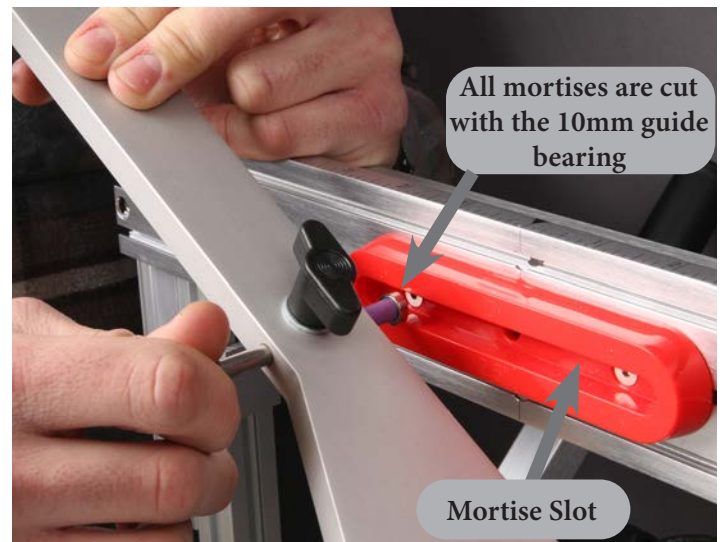

Magic in the mortise slot. In the ends of the mortise slots there are three steps to make the mortise a little wider than the tenon if you prefer a little wiggle room for adjustment during glue-up. Following the bottom of the mortise pocket with your guide bearing makes a perfect fitting mortise and tenon joint, which is always a good idea for through-mortises. The second and third steps allow a little more room at the ends of the tenons. Both ends of the mortise are end grain and there's much less strength in that part of the joint than the glued side grain so a little extra room doesn't significantly weaken the joint.





Clamps and clamp helpers. The standard clamps work in most situations, but for mortising, make simple clamp helpers like the one shown to get pressure where you need it. Avoid clamping directly over the area to be mortised, since the clamp could deform the mortise wall as the mortise material is cut away.

Set the depth of cut. The excellent solid carbide bits included with your PantoRouter® cut crisp, clean mortises.

Simply touch the bit to the workpiece and slide the depth stop just past the length of the tenon you'll cut next. About an 1/8" of room for excess glue at the bottom of the mortise is plenty.

Dust shroud brush goes back on. The highly effective and convenient dust collection hood has a brush-style shroud that comes off easily for set-up and goes back on just as quickly.



Note: If the brush ever gets smooched, go to our website in the Support section and find the Tech Tip called "Bad Hair Day" for an easy way to straighten the bristles.
www.PantoRouter.com

Mortising is fast and foolproof. Take shallow passes. We recommend 1/8"-1/4" per pass back and forth with the router bit, as several shallow cuts are better than deep aggressive cuts. Keep gently pushing forward with the plunge lever until the depth stop bottoms out. That's it! The dust shroud is removed for these photos but you'll definitely want to keep it on for mortise and tenon work.

The two Front Fence Stops on the table align the workpiece to the front of the table. They're ABS plastic to make it a little easier on the bit if one gets accidentally nicked. Once the workpiece is clamped in place the front stops can easily be slid out of the way.

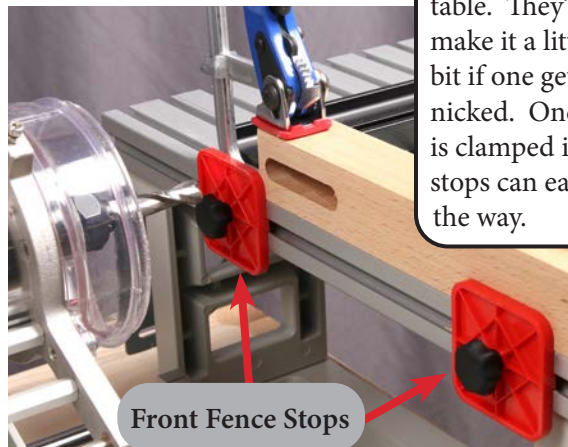
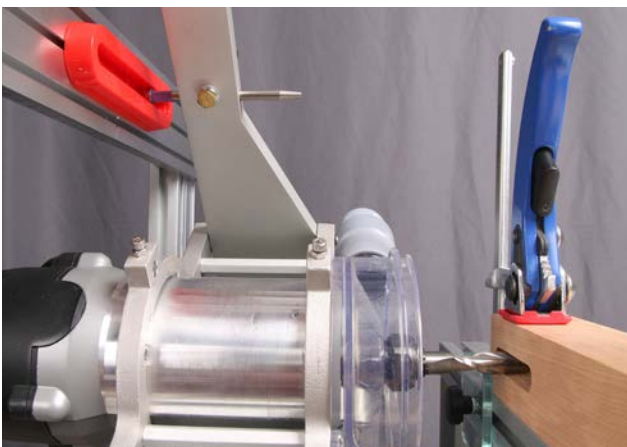

Front Fence Stops

Tenons second

Trace the outside of the template for tenons. We recommend using a 1/2" spiral up-cut bit for all tenon cuts except those cut using the diamond and bow tie templates. Consult the chart at the bottom of this page to determine the correct guide bearing for the desired tenon thickness. Also, push the guide bearing to the thickest part of the template closest to the template holder for your first tenon attempt.

The template is thicker toward the back so the tenon cut using that position will be thicker as well, usually too thick for the mortise, but it's the best place to start.

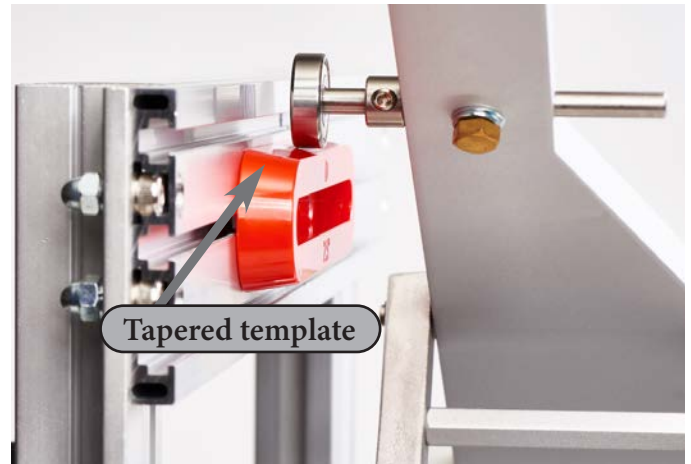

Bit and guide bearing selection

While most tenon sizes could be cut with multiple combinations of router bits and guide bearings, the 1/2" bit works for every tenon size. The 1/2" bit makes good, clean cuts, and is our recommendation for tenoning operations. Use the guide bearing quick select chart below when using the 1/2" diameter bit for tenons.

Guide bearing quick select chart for Tenons

1/4" thick tenon = **10mm** guide bearing with 1/2" bit
5/16" thick tenon = **12mm** guide bearing with 1/2" bit
3/8" thick tenon = **15mm** guide bearing with 1/2" bit
1/2" thick tenon = **22mm** guide bearing with 1/2" bit
3/4" thick tenon = **35mm** guide bearing with 1/2" bit
1" thick tenon = **48mm** guide bearing with 1/2" bit

Alternate Bit and Bearing Combinations: It's rare and usually less desirable that tenons would need to be cut with a bit other than 1/2" diameter, but in case a different combination is desired, this chart shows the possibilities. See the example below.

Tenon Size	GB	Bit
		1/2"
1/4"	6	1/2
	10	1/2
	22	3/4
3/8"	35	1
	10	3/8
1/2"	15	1/2
	10	1/4
	15	3/8
3/4"	22	1/2
	35	3/4
	48	1
	22	1/4
1"	35	1/2
	48	3/4

It's best to use larger guide bearings and bits where possible.
The 1/2" spiral upcut bit works with every size.
The 35mm (yellow) and 48mm (orange) guide bearings come with the Monster Set along with 3/4" and 1" straight cut bits.

Example: For a 1/4" thick mortise and tenon, the chart above shows three different combinations that can make the correctly-sized tenon. Since it's a 1/4" mortise and tenon, the mortise is cut with the 1/4" bit, then the bit and guide bearing are changed to make the tenon cut. The 1/2" bit with 10mm guide bearing is preferred, but the chart above also shows the 3/4" bit with the 22mm guide bearing or the 1" bit with the 35mm guide bearing will make the same 1/4" thick tenon.

The colors in the chart and on the guide bearing shafts in the photo are for clarifying the sizes, but we do not color-code the guide bearings for the PantoRouter® woodworking machine.

The chart below lists actual measurements of mortise and tenon widths when using the Essential Set of mortise and tenon templates, Segmented mortise and tenon widths are discussed later in this guide.

Note that the width changes depending on the mortise bit diameter.

Mortise and tenon width measurements for the Essential Template Set															
Mortise Bit Diameter	A (1")			B (1-1/2")			C (2")			D (2-1/2")			E (3")		
	Fraction	0.01"	mm	Fraction	0.01"	mm	Fraction	0.01"	mm	Fraction	0.01"	mm	Fraction	0.01"	mm
1/4"	3/4	0.70	17.8	1 1/4	1.22	31.4	1 3/4	1.73	44.0	2 1/4	2.24	56.9	2 3/4	2.73	69.4
5/16"	3/4	0.78	19.7	1 1/4	1.28	32.6	1 3/4	1.78	45.3	2 1/4	2.30	58.4	2 3/4	2.80	71.0
3/8"	7/8	0.83	21.0	1 3/8	1.34	34.1	1 7/8	1.84	46.8	2 3/8	2.36	59.9	2 7/8	2.85	72.4
1/2"	1	0.96	24.3	1 1/2	1.47	37.3	2	1.98	50.3	2 1/2	2.49	63.1	3	2.99	75.9
3/4"	1 1/4	1.21	30.8	1 3/4	1.72	43.7	2 1/4	2.24	56.9	2 3/4	2.75	69.8	3 1/4	3.24	82.2
1"	1 1/2	1.47	37.3	2	1.98	50.4	2 1/2	2.49	63.2	3	2.99	75.8	3 1/2	3.48	88.5

Notes:

Fractions are rounded to the nearest 1/8"

Templates marked B-V and D-V are for vertical M&T and are the same dimension as B and D above

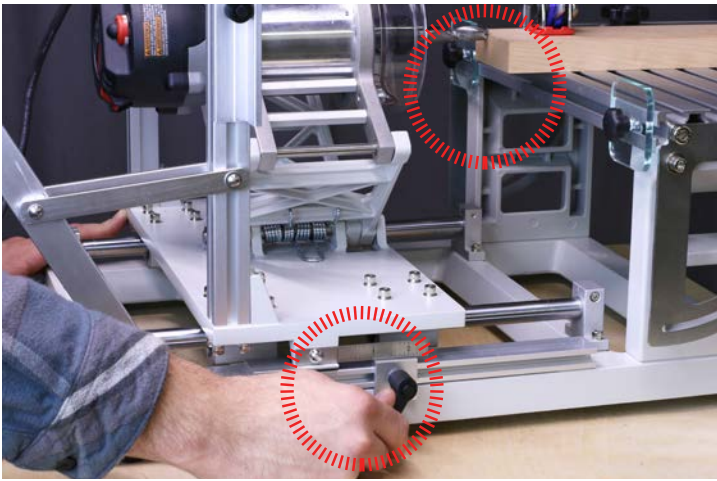

Reset the depth stop. Touch the tip of the router bit to the end of the workpiece then set the depth stop as before but the tenon must be slightly shorter than the mortise is deep.

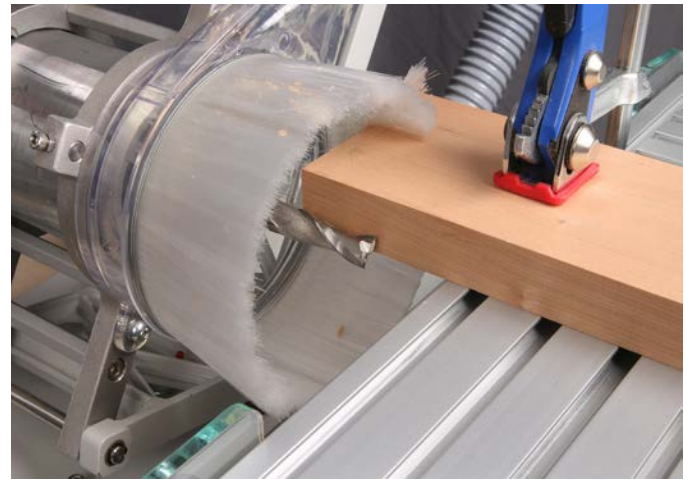

Safety check. Extend the workpiece far enough so the bit will clear the table at its full cutting depth. Be sure to move the front fence stops out of the cutting window of the router.

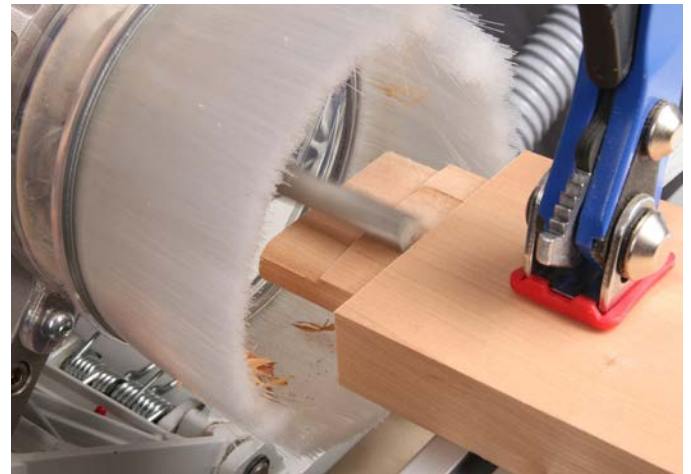

Tenoning is just as fast and foolproof. Start with your bit and guide bearing well off the workpiece and template then work your way around the perimeter, gently cutting the wood until the bit contacts the template. Use climb cuts for a clean shoulder, working your way deeper and farther down the tenon as you go, until the bearing is riding the template and the depth stop is bottomed out.

Note: be sure to wait for the bit to come to a complete stop before testing the fit. Be mindful of the location of the stopped router bit when checking the fit of your tenon.

Check the fit. The tenon could be just a bit tight at this point. Test the fit before un-clamping your workpiece in-case you need to make an adjustment.

Adjustments are amazingly easy. The templates have a tapered perimeter, so moving the guide bearing down the taper slightly adjusts the fit by a few thousandths of an inch. Once you dial-in the fit, you can crank out piles of cleanly cut, deadly-accurate tenons in minutes.



Longer tenons take multiple passes. The Spiral up-cut bits provided with the PantoRouter® have 2 cutting flutes. Depending on the bit, the length of these flutes vary. When cutting tenons, be sure to note the length of the flutes. The cutting flute length is the maximum depth that can be cut at once, tenons that exceed the cutting flute length can be cut but must be done in multiple passes as shown on the previous page.

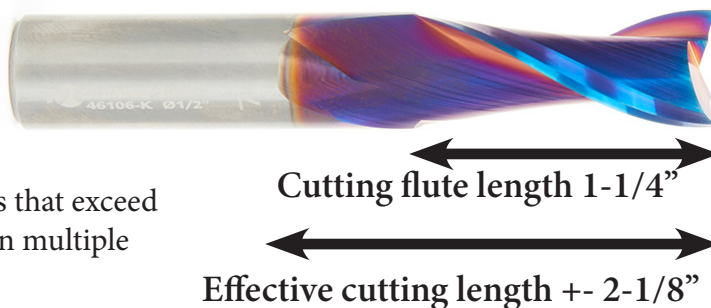

Tip: When cutting tenons longer than the cutting flute length, set your depth of cut to 1" first and dial in a perfect fit to the mortise. Then, reset your depth and cut the rest of the tenon.

It is not appropriate to begin your tenon cut with the guide bearing resting on the template then stabbing the bit into the workpiece. The correct method is to start with your guide bearing out in space and just skim the workpiece with the bit, cutting small amounts until your guide bearing finally gets to the template.



Using the guide bearing collars. Once you've identified the best fit for your bit and guide bearing, use one of the guide bearing collars supplied with the guide bearings to lock the position to quickly return to the "sweet spot" the next time you use that bit and bearing combination.

Tip: Make sure the stop collar is on the guide bearing shaft prior to making your first tenon cut otherwise you have to remove the guide bearing entirely and you will lose your place on the template.

Control over the router. The mechanical advantage ratio is about 2.5:1 at the handle, so you'll have perfect control, even though you are climb-cutting all the way. Listen to the sound of the router while cutting, you can hear the pitch change dramatically when the router is trying to take too much off in one pass.

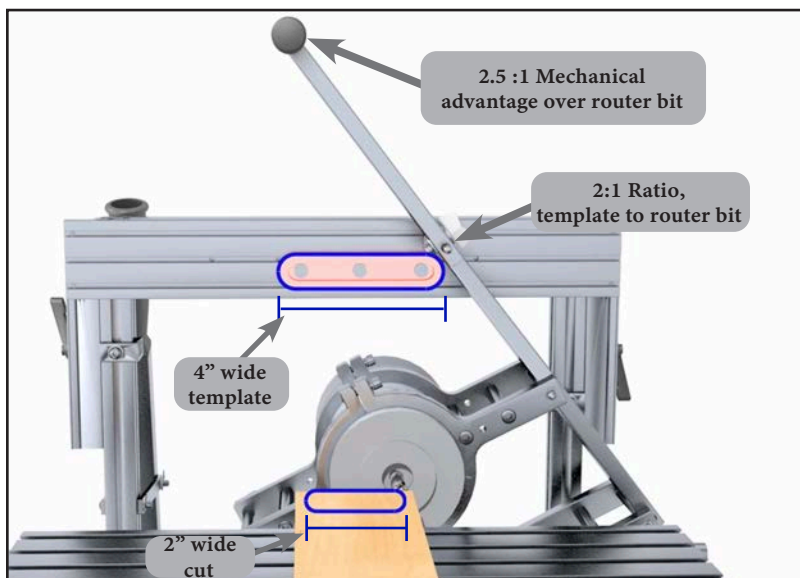

Multiple tenons are just as easy.

For wide workpieces, combine templates. Use a square and the scale on top of the template holder to align the templates. When two templates are used, they are usually spaced equidistant from center.

Make sure to leave room between them for the guide bearing to pass through.



Make a test run. To be sure the mortises and tenons will fall in the right place, cut mortises in some scrap.



Two mortises are almost as fast as one. You just need to stop to pull the guide bearing out of the center slot of one template and put it into the other.

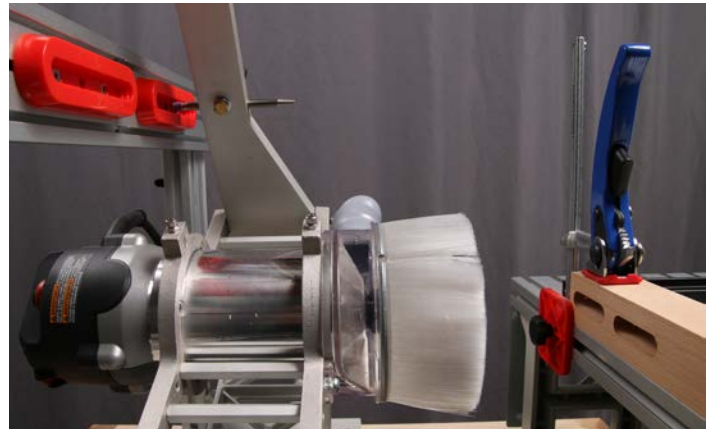

Two tenons in one minute. Like before, use climb cuts to make a series of shallow passes, working your way toward full depth, and adjust the guide bearing outward, down the taper to dial-in the fit.

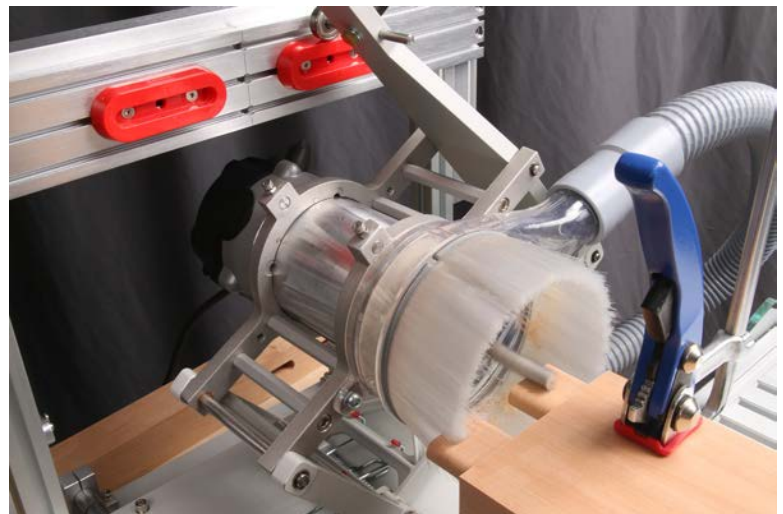

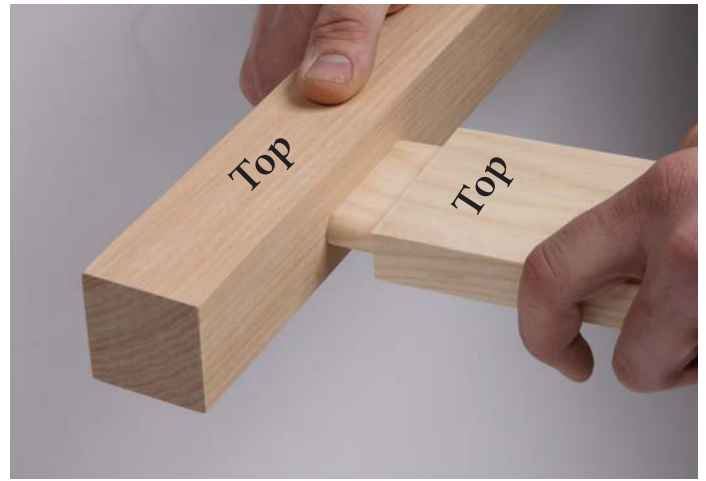

Perfection. Perfect alignment and a perfect press-fit right off the machine.

Mortise and tenon joinery notes

The mortise and tenon are mirror images so mark the top of each piece and use the fence as a reference surface whenever possible.

A light touch is key to accurate and repeatable joinery, listen to the sound of the router while cutting, you can usually hear when it is working too hard.

Angled Mortise and tenon joinery

The PantoRouter® makes single angle or compound angle joinery easy by using the auxiliary fence and the tilting table.

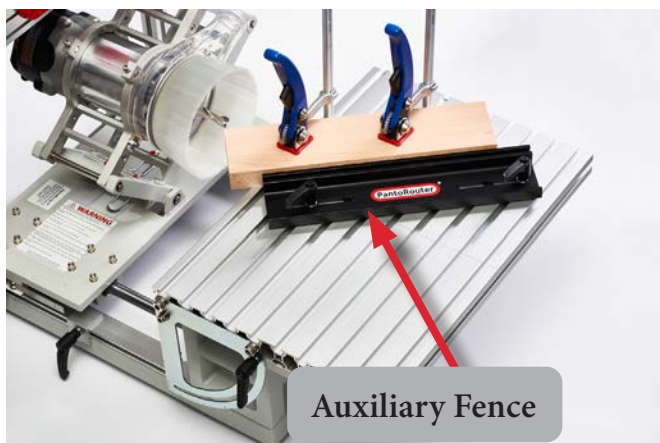

Compound angles are made much easier using the PantoRouter® but additional layout and setup steps are required. For more information visit <https://www.PantoRouter.com/video-library-overview-and-how-to>

Segmented Mortise and Tenon Templates

The Essential mortise and tenon templates used in the previous section can cut 35 sizes of mortise and tenon joints in minutes. The Segmented mortise and tenon set allows PantoRouter® users to cut 154 different sizes of round-end mortise and tenon joints and another 77 sizes of square-end tenons. Using the provided chart, it is easy to select the desired size M&T joint based on the project and quickly mount the correct pieces on the template holder. Similar to how the standard M&T templates are “optimized for 1/2” as described in the previous section, this set of templates is “optimized for 3/8” making these two sets complementary to each other. This opens up even more size combinations and possibilities. Consult the full-sized chart on page 42 of this How-To guide to see all of the sizes that can be made with any given template.



Three steps to selecting any of 154 sizes of round-end M&T plus another 77 sizes of square-end tenons.

1. Select the M&T thickness (mortise bit diameter)
2. Choose the desired width of M&T
3. Find the combination of end pieces and segments from the chart

Mortise Bit Size	1/8" M&T	1/4" M&T	3/8" M&T	1/2" M&T	3/4" M&T	1" M&T	Segment Combinations							
Guide Bearing	6mm	10mm	15mm	22mm	35mm	48mm	All tenons use the 1/2" bit and guide bearings listed to left							
Mortise and Tenon Width (Rounded to 1/16")	3/4	7/8	1	1 1/8	1 3/8	1 5/8	●	●	Circle marked round-end pieces only					
	1	1 1/8	1 1/4	1 3/8	1 5/8	1 7/8	●	●	Triangle marked round-end pieces only					
	1 1/4	1 3/8	1 7/16	1 5/8	1 7/8	2 1/8	●	1/2"	●	End with segments of nations				
	1 1/2	1 5/8	1 7/8	1 7/8	2 1/8	2 3/8	●	1/2"	●	End with segments of nations				
	1 3/4	1 7/8	2	2 1/8	2 3/8	2 5/8	●	1"	●	End with segments of nations				
	2	2 1/8	2 1/4	2 1/4	2 5/8	2 7/8	●	1"	●	End with segments of nations				
	2 1/4	2 3/8	2 1/2	2 1/2	2 5/8	2 7/8	3 1/8	●	1 1/2"	●	End with segments of nations			
	2 1/2	2 5/8	2 3/4	2 3/4	2 7/8	3 1/8	3 3/8	●	1"	●	End with segments of nations			
	2 3/4	2 7/8	3	3	3 1/8	3 3/8	3 5/8	●	1"	●	End with segments of nations			
	3	3 1/8	3 3/16	3 1/4	3 3/8	3 5/8	3 7/8	●	1"	●	End with segments of nations			
	3 1/4	3 3/8	3 7/16	3 1/2	3 5/8	3 7/8	4 1/8	●	1"	1/2"	●	End with segments of nations		
	3 1/2	3 5/8	3 11/16	3 3/4	3 7/8	4 1/8	4 3/8	●	1"	1/2"	1"	End with segments of nations		
	3 3/4	3 7/8	3 15/16	4	4 1/8	4 3/8	4 5/8	●	1"	1"	1"	End with segments of nations		
	4	4 1/8	4 3/16	4 1/4	4 3/8	4 5/8	4 7/8	●	1"	1"	1"	End with segments of nations		
	4 1/4	4 3/8	4 7/16	4 1/2	4 5/8	4 7/8	5 1/8	●	1"	1 1/2"	1"	End with segments of nations		
	4 1/2	4 5/8	4 11/16	4 3/4	4 7/8	5 1/8	5 3/8	●	1"	1 1/2"	1"	End with segments of nations		
	4 3/4	4 7/8	4 15/16	5	5 1/8	5 3/8	5 5/8	●	1 1/2"	1"	1"	1/2"	End with segments of nations	
	5	5 1/8	5 3/16	5 1/4	5 3/8	5 5/8	5 7/8	●	1 1/2"	1"	1"	1/2"	End with segments of nations	
	5 1/4	5 3/8	5 7/16	5 1/2	5 5/8	5 7/8	6 1/8	●	1 1/2"	1"	1"	1"	End with segments of nations	
	5 1/2	5 5/8	5 11/16	5 3/4	5 7/8	6 1/8	6 3/8	●	1 1/2"	1"	1"	1"	End with segments of nations	
5 3/4	5 7/8	5 15/16	6	6 1/8	6 3/8	6 5/8	●	1 1/2"	1"	1"	1/2"	1"	End with segments of nations	
6	6 1/8	6 3/16	6 1/4	6 3/8	6 5/8	6 7/8	●	1 1/2"	1"	1"	1/2"	1"	End with segments of nations	

* View the Full sized chart on page 42

The two end pieces marked with the circle make a 1" wide M&T at 3/8" thick.

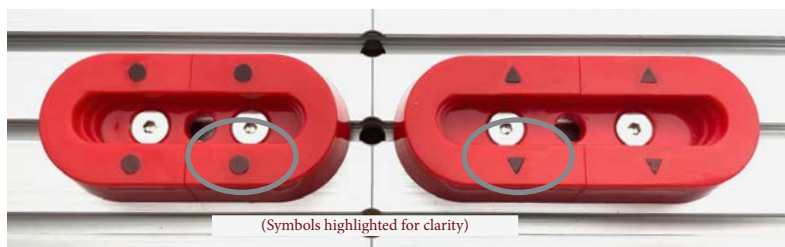

The two end pieces marked with the triangle make a 1-1/4" wide M&T at 3/8" thick.

Hundreds of possibilities from eleven segments. After consulting the provided chart, select the correct segments from your segmented template set.



Note: The square end templates are for making the tenon ends square. The mortise still needs to be squared with a chisel, but at least we get you half way there!



Finding center. Determine which of the segments will be in the middle of the array and use one of the non-tapered guide bearing shafts to center the template array on the template holder. This works for either the round-end or square-end templates.

To center an array of segments that does not have a center hole option, use a square to locate each end equidistant from the center of the template holder. The metric scale on the template holder is easiest for this.

A mortise and tenon 1/8" larger or smaller than the chart can be made using one circle end piece and one triangle end piece. Center the combination of segments using this measuring method since the centering holes will be off by 1/8".



The three steps in the mortise slot allow three widths of mortise. Use the lowest step when you need a perfect fit side-to-side such as for through mortise and tenon. Use the second or third step if you prefer a little side-to-side adjustability. This can sometimes be helpful during glue-up. Using the third step also allows room to wedge the tenon.

Note: Mortises are cut using the 10mm guide bearing in the mortise slot and router bit with a diameter equal to the mortise thickness. Tenons are cut using the 1/2" spiral up-cut bit and the appropriate guide bearing for the desired tenon thickness. A chart to determine guide bearing size when using a 1/2" bit can be found on page: 12.

Slot Mortise Template

The Slot Mortise Template is a fast and easy way to cut any width slot and can be set up for either inch or metric sizes. This flexible template system is a great choice for cutting mortises for floating tenons, bridle joints, hand holds, finger grooves, and more! Simply align the bit size with the desired mortise width to cut a perfect mortise. The template can also be used for bridle joints and many other uses where a wide, side-to-side movement is desirable.

Example: To cut a $\frac{1}{2}$ " thick mortise $1\frac{1}{2}$ " wide, align the mark for bit diameter ($\frac{1}{2}$ ") engraved on both left and right sliding stops with the desired mortise width ($1\frac{1}{2}$ ") on both sides of the centerline on the template holder (marked by the triangle).

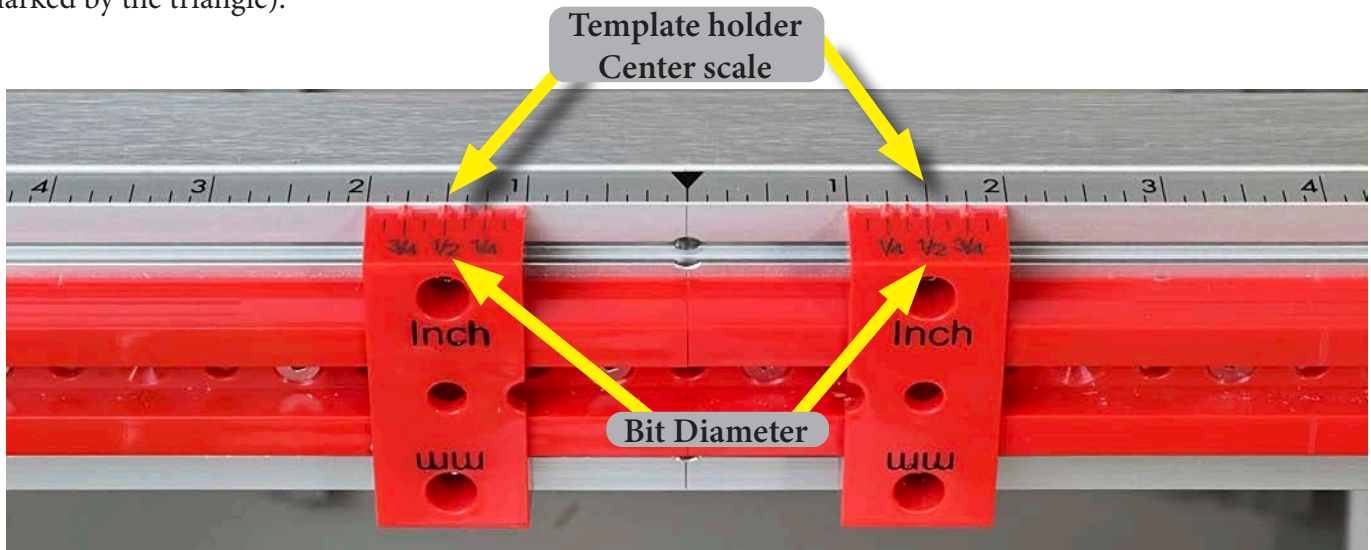

Metric sizes like this 8mm x 22mm mortise are set-up the same way on the metric side of the template holder.

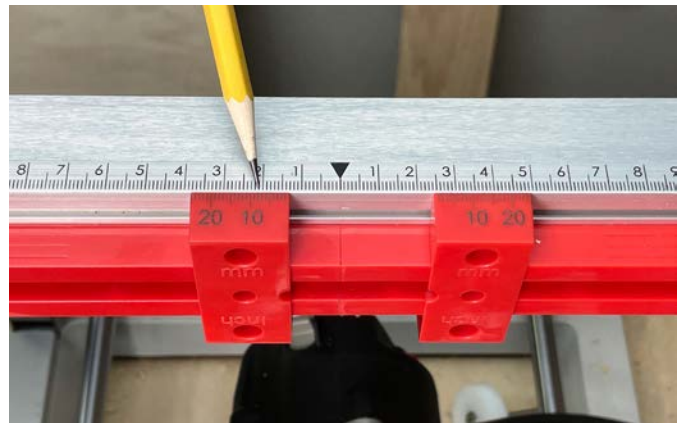

Each template set includes two long bars and two pairs of sliding stops. The half-circle cutout on the inside edge of each sliding stop accepts exactly half of the guide bearing, allowing the quick, accurate, math-free setups illustrated throughout this guide.

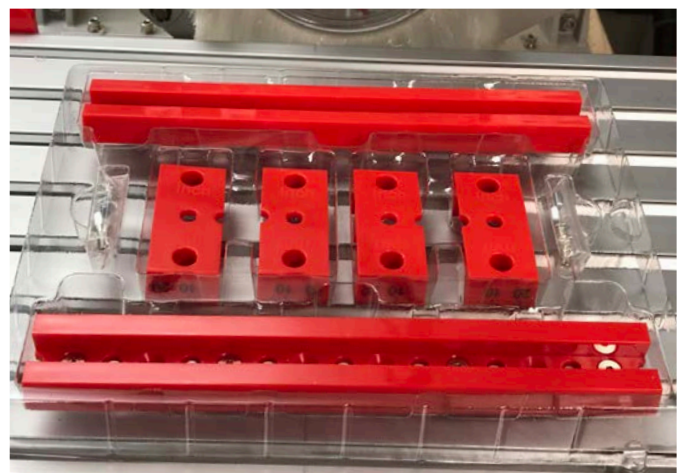

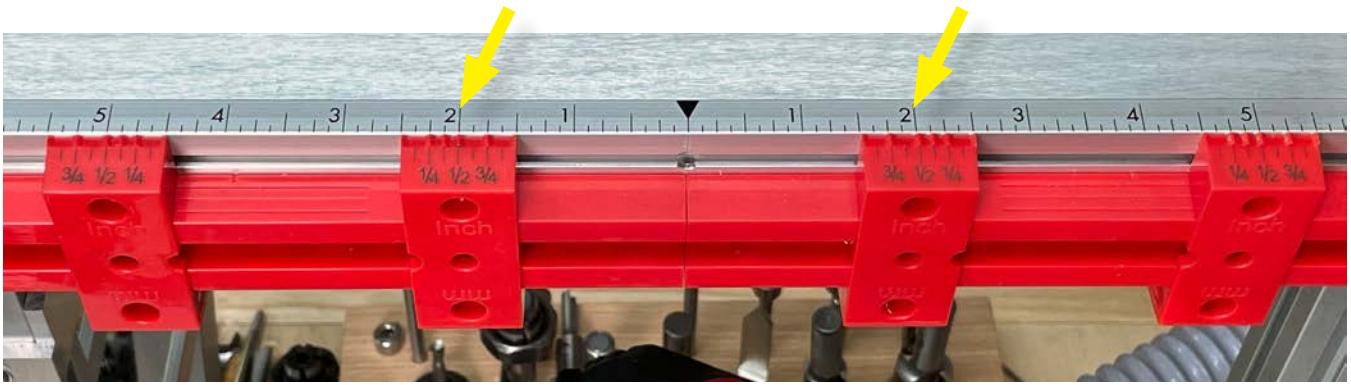

Double mortises. For double mortises, align the bit-diameter mark on the two sliding stops closest to the centerline with the desired distance between the two mortises.

In this case the 1/2" thick mortises are set to be 2" apart.



Use the centering ruler to space the mortise widths for each side.

This set-up is for the 1/2" mortise shown above.

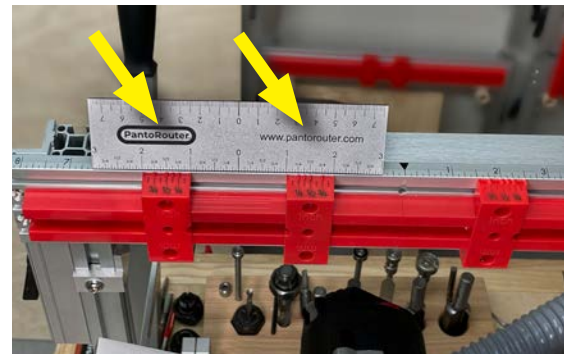

Using floating tenons. To use factory-made floating tenons, simply measure the thickness and width of the tenon. They can be made super-tight side-to-side or looser according to your needs.



Align the bit diameter engraved on the sliding template with the mortise width on the template holder.

Tip: Metric bits are available with inch-size shanks or with metric shanks, which require a collet adapter for each metric shank size.



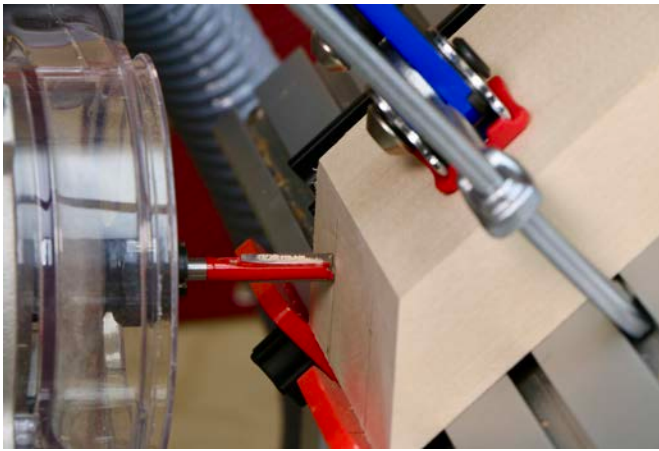

A $\frac{5}{16}$ " bit makes a nice snug fit for the 8mm floating tenon in this mitered joint example.



Double floating tenons in the angled workpiece on the PantoRouter® joinery machine took only a couple of minutes longer.

Note: Some metric router bits have metric shafts and others have inch scale shafts. Make sure the collet you are using is designed to work with the router bit shaft that you are using. It may appear to fit at a quick glance, but it could come loose and be dangerous if they are not compatible.

Bridle joints. Use the same easy set-up and cutting method as mortise and tenon. From start to finish, the joint is ready for glue in about three minutes.



- 1- Center the bit to the workpiece thickness using the thickness gauge.
- 2- Center horizontally on the table using the centering scale fence.
- 3- Cut the mortise first using the bit selected for the thickness of the cut.
- 4- Adjust the thickness of the tenon piece using the tapered template bar
- 5- Cut the tenon, sized to perfectly fit the mortise.
- 6- The bridle joint fits perfectly with no handwork required.

A world of other slots and details

Long mortises, grooves, and decorative features like this finger-hold are fast, easy, accurate and repeatable.

A $\frac{1}{2}$ " round-nose bit was used to make the groove exactly 5" long.



Dovetails are fast and foolproof

Your PantoRouter® package comes with 2-in-1 dovetail templates to cut both pins and tails with the same templates, just like the templates for mortises and tenons. The template for each pin/tail is a separate unit and they can be attached along the template holder in any array to create a pleasing layout for workpieces up to 8 inches wide.

Get ready to make beautiful through-dovetails in minutes, with the custom spacing that is the hallmark of fine dovetails, and a perfect fit every time.

The PantoRouter® joinery machine can cut through-dovetails in boards up to 1¼ inch thick.

Set-up is straightforward. You can simply place the guide bearing against the template and the bit against your actual workpiece to plan the perfect array, and off you go. The following photos will take you through the steps, including the process for cutting asymmetrical dovetails, useful on certain boxes and drawers.

Please read through the whole section before cutting dovetails for the first time on the PantoRouter® joinery machine. There are some great tips and tricks you won't want to miss.

Identify Your Templates

There are three versions of the red variably-spaced dovetail templates. Over the years, we have modified and improved upon these templates. While all three versions are used in much the same way and the core principles are the same, it is important to identify which ones you are using as there are subtle differences.

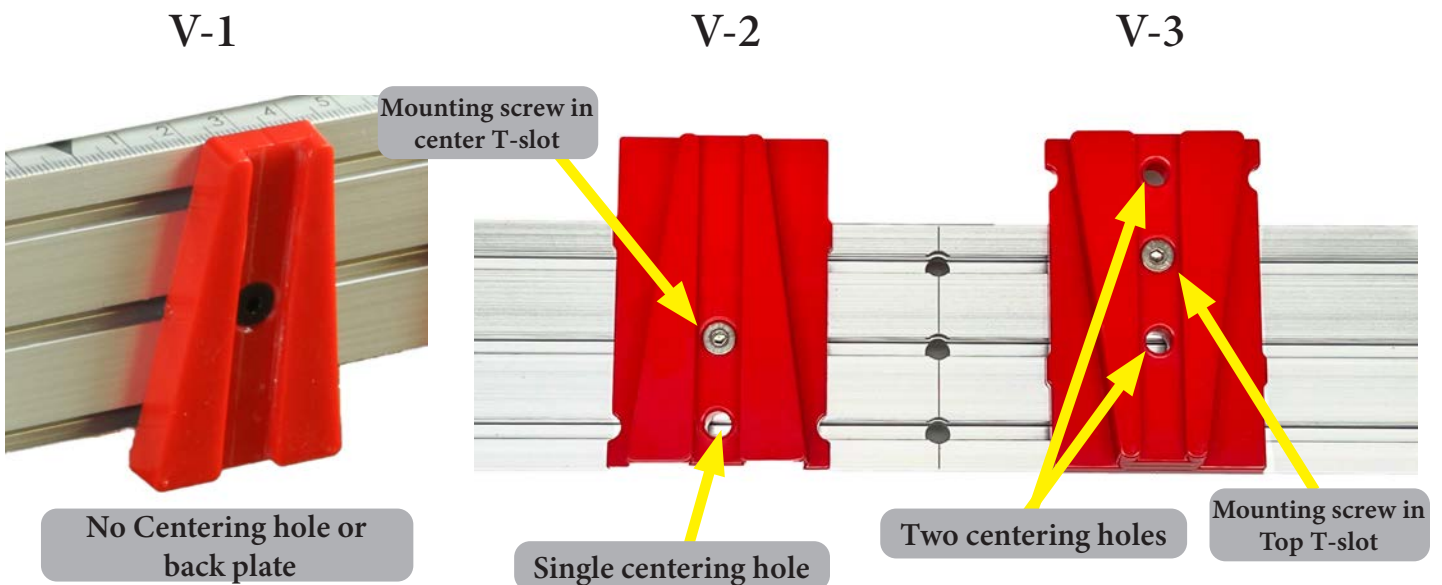

The major difference between V-2 and V-3 is the orientation in which the template is intended to be installed on the template holder. The V-2 templates have sloped sides that look like the letter “A” when installed correctly and the sides of the V-3 templates make the letter “V”.

To find instructions on using the V-1 dovetail templates, you can find older versions of the How-To Guide on our website www.pantorouter.com/getting-started/#how-to-guides

Center the workpiece using the Centering Scale Fence. The PantoRouter® fence includes a half-scale ruler, letting you measure any board and align the corresponding dimension on the fence with the centerline on the PantoRouter® table.

Note: this step is critical for successful dovetails, a workpiece that is not accurately centered will result in the pins board and tails board not aligning correctly. Refer to the technique on page 10 to see a quick method of double checking that you are perfectly centered on the table.



Template selection and placement

The dovetail templates provided with the PantoRouter® can be used to make fixed-space dovetails by pushing the templates tight to one another on the template holder, or the templates can be spaced apart on the template holder to cut variably-spaced dovetails.

How you lay out your dovetails comes down to personal preference for the project you are working on. Variably spaced dovetails with a half pin on either end is a very common and traditional look. Chose an array that's pleasing to you.



Select and Center your templates. Determine how many templates are appropriate for the desired layout and size workpiece. Load all of the templates you intend to use on the template holder, then adjust and fix their position.

Align the centering hole in the template with the center hole in the template holder to accurately locate your middle dovetail template.

Perfect half pins on the end made easy

Unplug the router and snug the split-shaft centering jig in the router collet. With the two outer templates still loose on the template holder, insert the guide bearing shaft in the centering hole of one of the outer templates.

Slide the template with the pantograph arm until the face of the split shaft centering jig contacts the edge of your workpiece. Tighten the template screw and repeat this process on the other side.

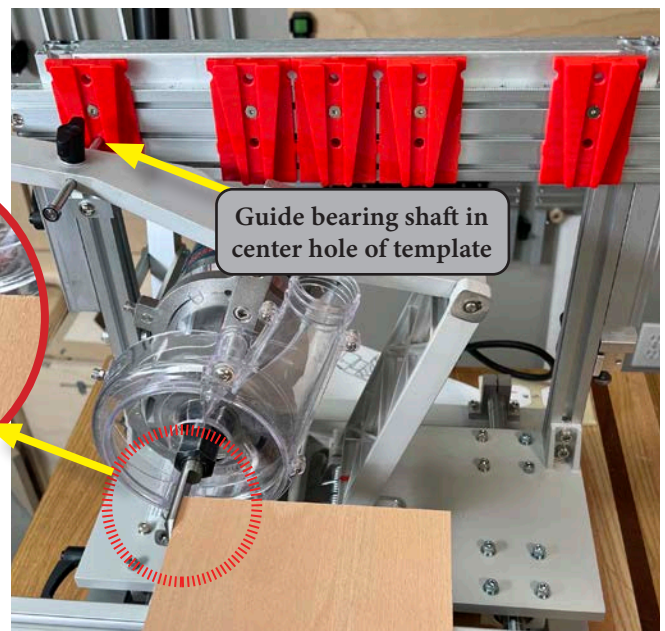
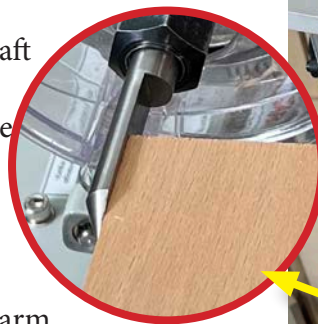

Centering ribs on the back.

Each dovetail template has a centering rib molded into the back to use in conjunction with the centering scale printed on the top of the template holder. Use these ribs to make sure the templates are laid out in a symmetrical pattern.

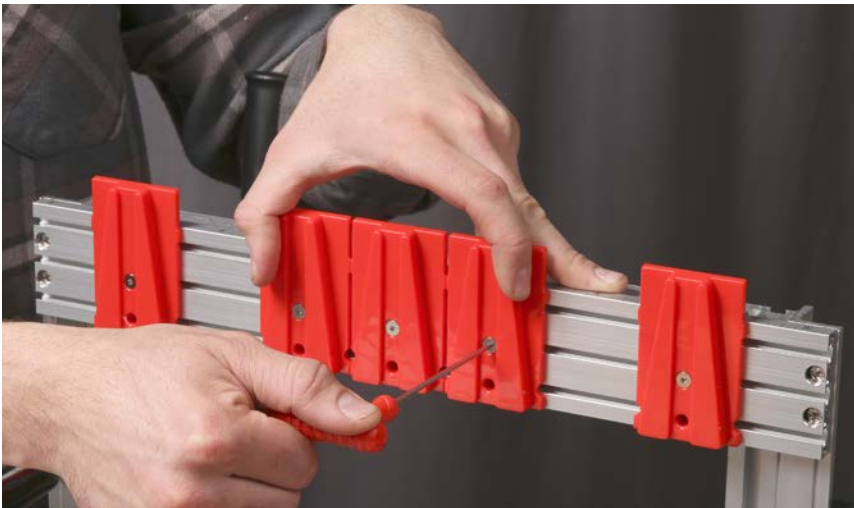
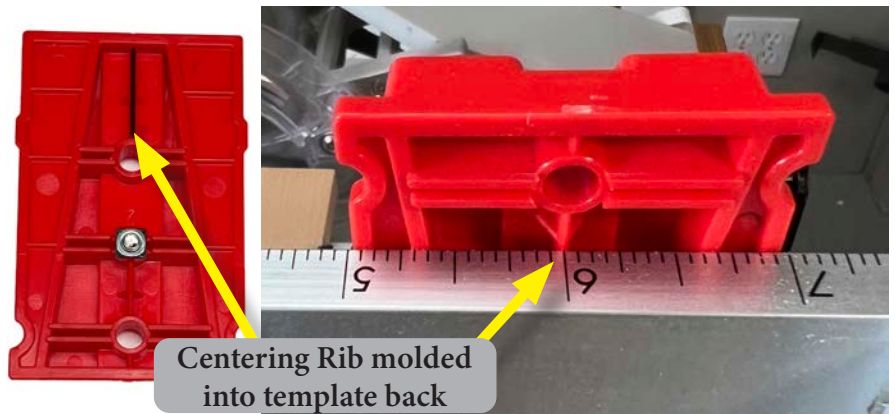

Set the rest. To create a symmetrical array, align the template centering ribs on the backs of the templates to the scale on top of the template holder.

Be sure the templates are far enough apart to allow the bearing to pass between the templates when riding the outside of the templates to cut the pins. For most bit and bearing combinations the 10mm or 15mm bearings are used so this is generally not a problem.

Fixed-space dovetails are easily cut by pushing the template segments together.

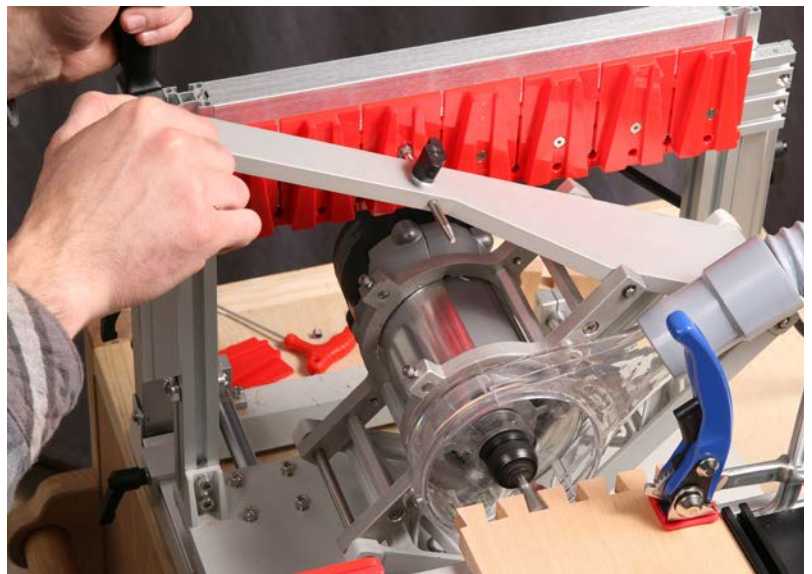

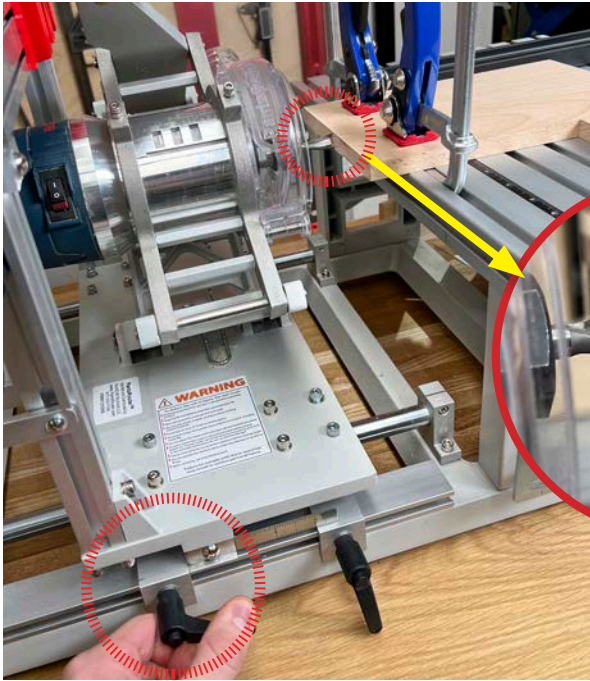

Set the depth. Load the high-quality dovetail bit supplied with your PantoRouter® or an 8° bit of your own, touch the end of the bit to your workpiece and set the rear depth stop. Make sure enough of the board is overhanging the table so the bit doesn't hit and damage the bit or table.

About 1/2" (~12mm) clearance is adequate.

Too much overhang can cause excessive vibration.

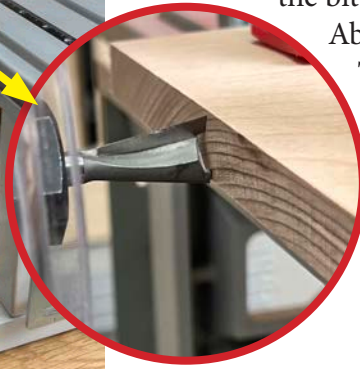

Use your workpiece to set the depth.

Place your workpiece between the protruding tab on the pantograph carriage and the front depth stop and tighten the lever knob. A piece of blue painters tape wrapped around your work piece when using this method ensures the depth of cut is slightly deeper than the thickness of your workpiece which is easy to make flush after glue-up.

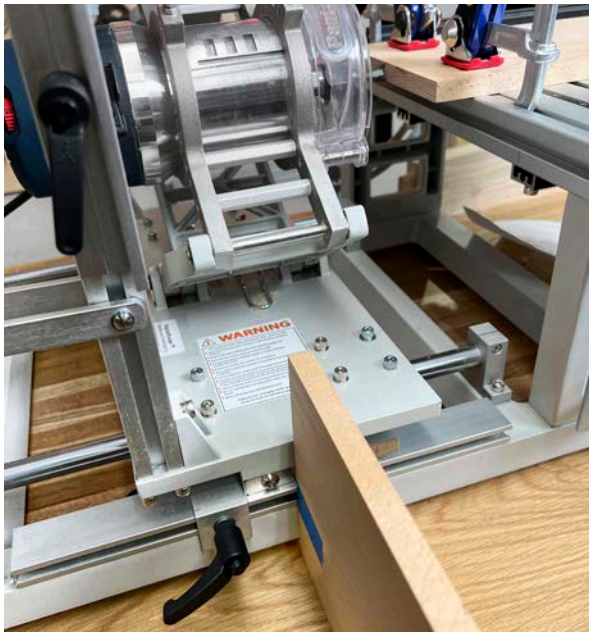

Note: if the tails board and pins board are different thicknesses, use the pin board to set the depth of cut for the tails and vice versa for setting the depth of the pins.

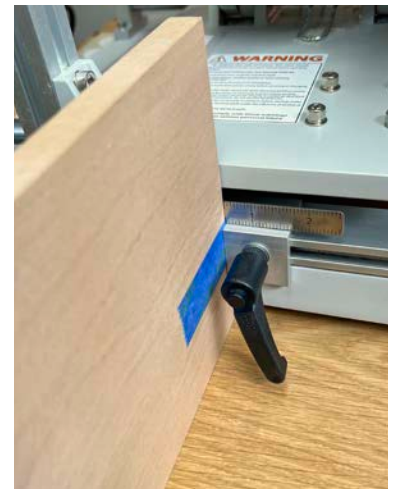

Cut stacks of tails

Tails are fast and easy. You can machine stacks of boards in minutes, with the PantoRouter's dust shroud grabbing every bit of waste. The bearing goes in the template's center slots for cutting tails. Follow gently along each side of that slot to be sure you are making full cuts, and slow down when breaking through the bottom of the board to prevent tear-out.

Gentle and even pressure is the key to making consistently accurate dovetails with the PantoRouter®.

The secret to Dovetail Success

Cut two sample boards about 6" long and milled to the same dimensions as your workpieces; one will be a test board for the tails and the other will be for pins. Cut tails in this board as you cut the rest of your workpieces. This sample tails board will be used to dial-in your fit for perfect pins. Since your sample tails board is short, you can use it to adjust the fit of your pins while the sample pins board is still clamped to the table. This step is essential when using the V2 dovetail templates. With the V3 templates being inverted, you can test the fit of your pins with any length board.

Although the sample board is not essential with the V3 templates, the shorter board can be a bit easier to maneuver and it prevents your nice finished tail boards from getting dinged or loosened from the process of testing the fit.

Tip: Record your bits, bearings and final distance from the top of the template holder to the top of the template holder support post so you can quickly repeat the process in the future. You can cut a set-up block that goes between the Thickness Gauge and Template Holder at your final location to dial in the fit even faster next time you cut dovetails.



Setup trick for perfect pins

Transfer the tails layout. The fit of the pins is adjusted by moving the template holder up or down, which moves all the templates along with it. To dial in the fit from the get-go, try the following. Clamp a tails board to the top of the PantoRouter® joinery machine table as shown, and use the supplied clamps to attach the pins test board vertically aligned with the tails board above. Scribe part or all of the tails layout onto the pins board test piece.

These scribe lines will be used as visual references for setup, so you only have to transfer them onto one end of the workpiece.

Change to a spiral up-cut bit. Most dovetail operations use the 1/4" or 3/8" straight spiral up-cut bit for the pins. When using the 1/2" dovetail bit provided with the machine for the tails, we recommend cutting the pins with the 3/8" spiral bit and a 10mm guide bearing.

With the pins board with scribe lines clamped to the table, place the 10mm guide bearing on one of the sloped sides of the templates. With the bit barely touching the end of your workpiece, slide the template holder up and down and notice how the relationship between the edge of the router bit and the transferred line on the end of the workpiece changes depending on the height of the template holder.

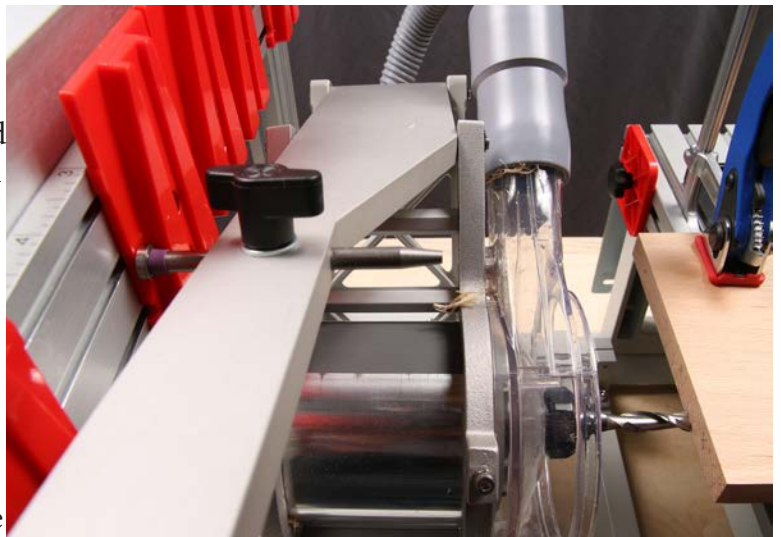

Note: with the V-2 templates, you will start with the template holder higher up and adjust the template holder down to make the joint looser. When using the V-3 templates, you will start with the template holder down towards the thickness gauge and make adjustments to the fit by moving it up.

Template holder Quick set

When using the provided 1/2" dovetail bit to cut the tails, use these quick references for the template holder location as a starting point when setting up to cut pins with a 3/8" bit and 10mm guide bearing.

V-2 Templates



Start with the top of the template holder approximately 1-3/16" from the top of the template holder vertical support post. This will likely be too tight, to make the fit looser adjust the template holder **DOWN**, by 1/32"-1/16" and make another pass.

V-3 Templates

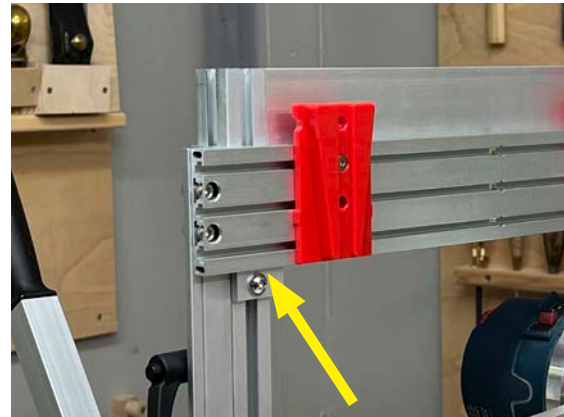

Start with the template holder resting on the thickness gauge and make a test cut. This will likely be too tight, to make the fit looser adjust the template holder **UP**, by 1/32"-1/16" and make another pass.

Set the template height. Holding the bearing against one side of a template, move the template holder up and down until the router bit is aligned just outside of your pins layout. Lock the template holder at that height.

Note: the bit still needs to be able to clear the top and bottom of the workpiece while remaining engaged against the template sides. Do a quick safety check by running the bearing up and down the side of the template with the router off to make sure you have proper clearance.



If the bit cannot touch the layout line for the pins regardless of the position of the template holder, or if the bearing goes off the template when the bit will still be cutting, try changing the bit or bearing diameter. Once you have the right combination, record it for future use.

Don't forget to set the depth. Any time the bit is changed, the depth needs to be reset. set the depth stop using the depth gauge or by using your workpiece as described in the tails section on Page 26.



Cut test pins. It is a good practice to use a test board to dial in the fit of your pins. Make small adjustments and check the fit with your tails test board after each pass. Repeat this process until you achieve the desired fit. Keep in mind that common PVA wood glues contain water which will swell the joint slightly when gluing two boards together. If it is too tight to dry fit by hand, it will likely be difficult to glue together.

Once you have the perfect fit, record the height of the template holder with a simple pencil mark on the vertical support post so you can repeat the process next time you make dovetails.

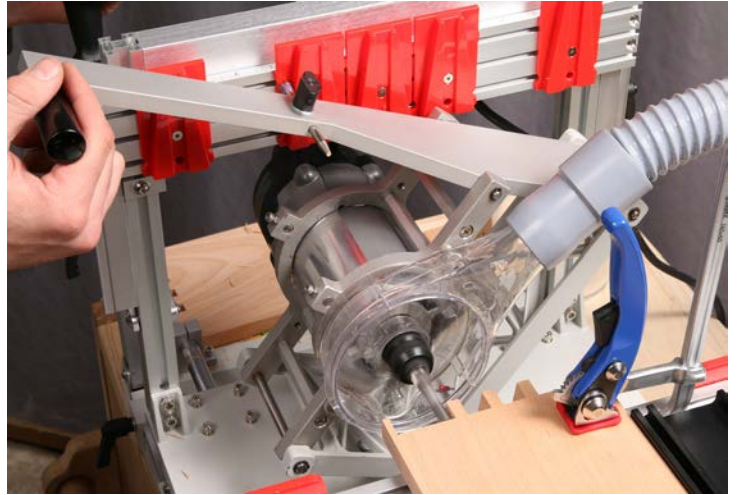

Cut pins with confidence

Nothing changes. For perfect-fitting pins, the templates stay right where they are, and you simply ride the outside edges. The fence also stays put. Once again, slow down when breaking through the bottoms of your cuts, and tear-out will be virtually eliminated.

Tip: As mentioned before, the PantoRouter® does not require a heavy hand. When cutting your test pins, note the amount of pressure you are applying to the template with the guide bearing and how many times you are going up and down each template side. For the most accurate results, try to replicate that pressure and procedure on all of your cuts.

Proof is in the pudding

Stacks of perfect dovetails. The 2-in-1 templates ensure a perfect fit, no matter how you space the pins and tails



KEEPING TRACK OF THE DOVETAIL PIECES

Mark your boards. It helps to layout the joint with marks showing which edge will be registered to the operator's side.

For V2 templates: The tails piece will be cut upside-down so it will have the arrow pointing toward the table. The pins piece will have the arrow pointing up.

For V3 templates: The pins piece will be cut upside-down so it will have the arrow pointing toward the table. The tails piece will have the arrow pointing up.

Asymmetrical Array. The PantoRouter® can be used to make asymmetrical arrays of dovetails and when doing so it's especially important to keep track of which sides of the piece you're cutting.

Always start with the tails. Reference the A-Edge toward the operator's side of the table and the outside face down against the table, then cut the tails.

Cut a sample piece of the tails so you can fit the pins while the pins piece is still on the PantoRouter® table. The sample piece should be in the same stock as the workpiece and about 6" long.

Cut all of your tails exactly the same. Remember that routing is a subtractive operation so if you go back over a cut it will take at least a tiny bit more off the piece. Whatever you do to one cut should be done to all of the others.

Cut the Pins. Cut the pins and fit them to your sample tails piece. Once the fit is perfect, cut all the pins pieces at once.

It's important with dovetails to glue them up right away. We recommend milling the wood to rough dimension and letting it rest for as long as it takes to minimize movement. Do your final milling just before cutting dovetails or box joints, then immediately glue it up to minimize board warp and make your joints tighter and easier to finish.

Please watch our Dovetail How-To Video in the Support Tab on our website to see more tips and tricks for making perfect dovetails on your PantoRouter® woodworking machine.

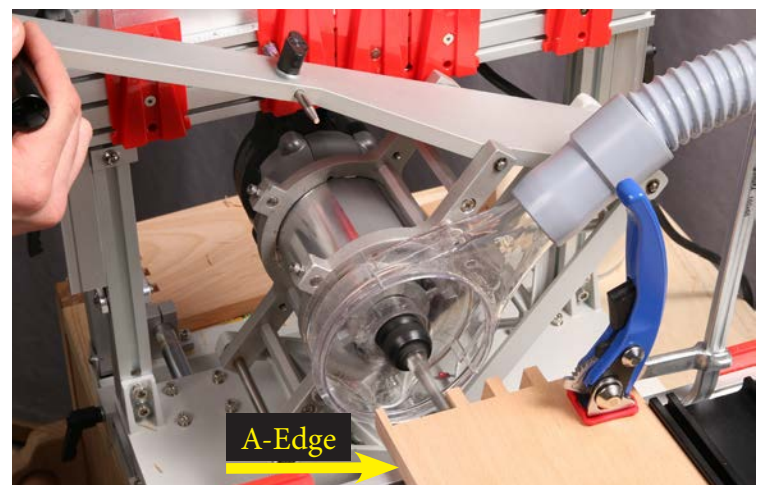
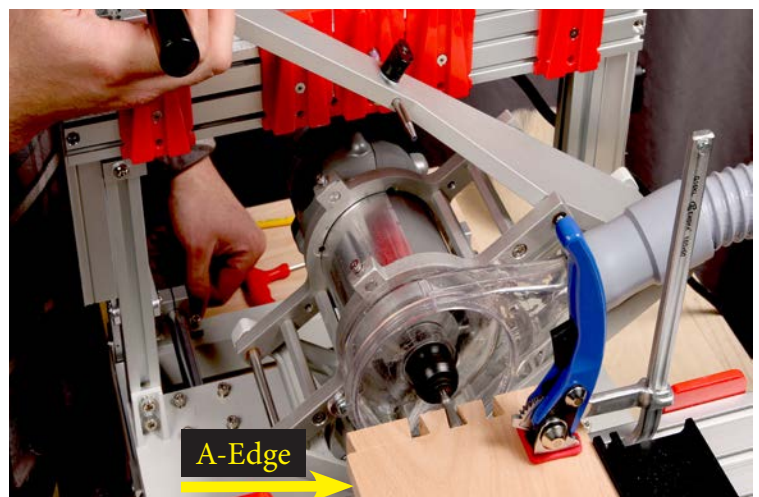

Variably Spaced Dovetail Tip:

This box was fully assembled then the lid cut off on the table saw. Since the templates were spaced to accommodate for the saw kerf, the dovetail spacing returned to symmetrical after the lid was removed. Very Cool!

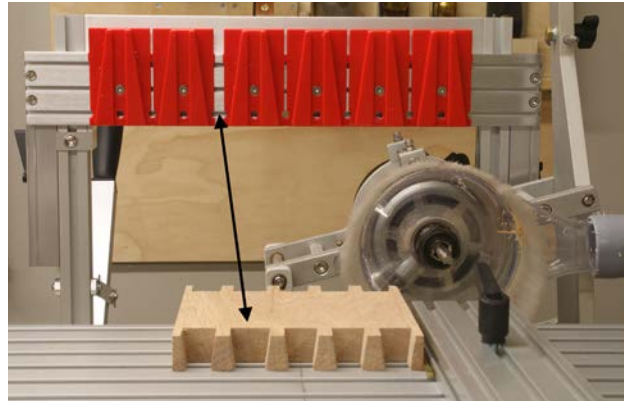

A 1/4" spacer was used to account for the 1/8" blade since most everything on the PantoRouter® is 2:1. Once the lid was separated from the body, the dovetails are evenly spaced.

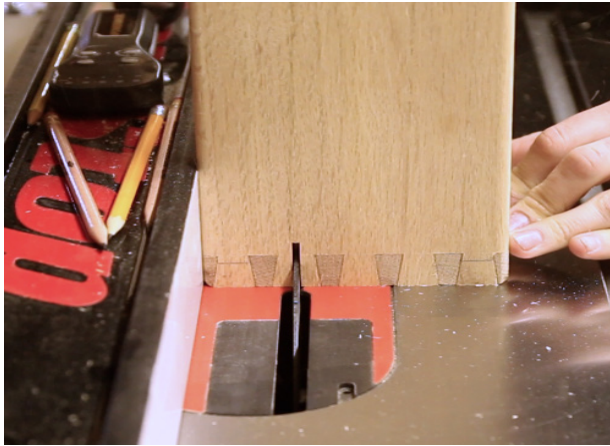

Dovetails wider than 8"

Wide boards for cabinets, chests, and case pieces can be cut using the PantoRouter® by cutting a section of the board and then sliding the workpiece over and indexing it to cut the next section. This trick works for fixed space dovetails and box joints but requires careful setup and execution.



Photos courtesy of: Casey Marwine



Watch a video on wide dovetails by Cosmas Bauer by scanning the code.



Great trick for asymmetrical dovetails

For some boxes and drawers, you'll want an asymmetrical array, which will need to be reversed for opposite corners of the box. Here's how to reverse any template array.

Record it. Get the templates where you want them for one of the joints, and use a long folded piece of paper as a story stick for marking the centers of the templates as well as the center of the template holder. Then cut pins and tails as usual.



Reverse the array. To create the same array in reverse, just unfold the paper and extend your marks a little. Now you can fold and flip your paper ruler, and use the marks to re-center the array on the template holder and reset all of the templates.

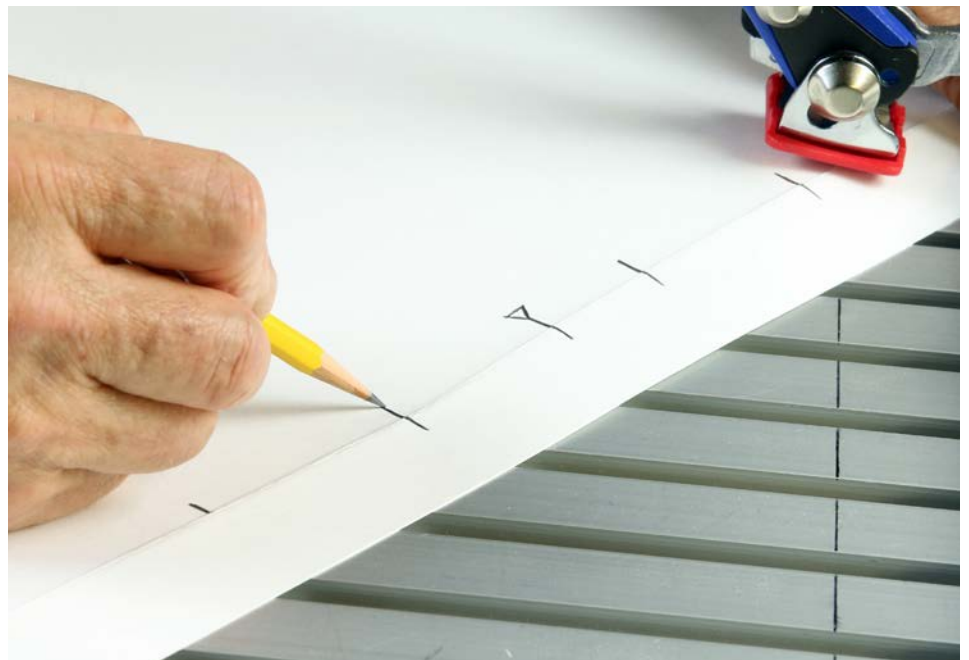

Box joints in minutes, with no fitting

Even easier than it cranks out mortise and tenon and dovetails, the PantoRouter® uses segmented templates to make immaculate box joints in two sizes, with perfect joints right off the machine—no sample boards or fitting required. For 1/2-in. fingers, use the 1/2-in. bit supplied and follow the slots over the top of the templates. For 1/4-in. box joints on smaller projects, use the 1/4” bit and follow each slot from the bottom of the template. The 10mm (~3/8”) guide bearing is the same for both.

There isn't much more to say, other than when the segments are all pushed together the spacing is fixed, meaning only certain board widths will give perfect fingers on the ends of a joint. Stock that's a multiple of 1/4” or 1/2” will have full fingers on the ends but if you don't mind partial fingers, you can use workpieces of any width. Also, the tall box joint template lets you cut joints in stock up to a hefty 1-1/2” thick.

You can add a space in your box joint array by sliding the segments apart. For instance, if you want to make a box and glue-up all 6 sides then cut the top off at the table saw, you can add 2X your saw blade kerf at the appropriate place then when you cut the lid off, your box joints will again be perfectly spaced. Check out the Video Tech Tip on this on our website.

Soon you will be finding all sorts of reasons to use these clean-looking box joints, from shop trays and cabinet drawers to quick gifts for clients, friends and family.

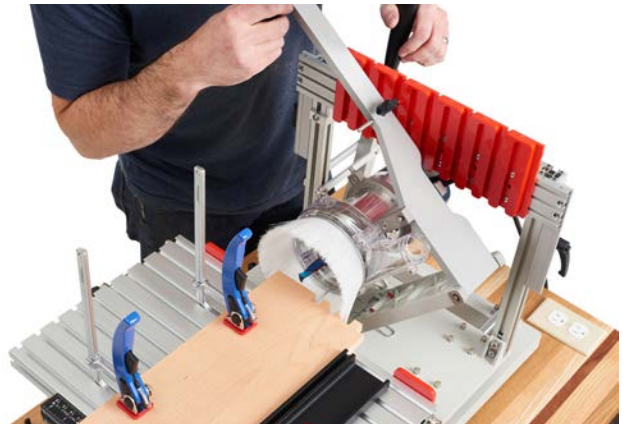

Cut one side of the joint

Center the workpiece using the Centering Scale Fence. The PantoRouter® fence includes a half-scale ruler, letting you simply measure any board and align the corresponding dimension on the fence with the center mark on the PantoRouter's table.



Set the depth. The traditional method of determining depth of cut is to scribe a line on the workpiece then align the bit to cut to that depth or a little beyond if you prefer the tail, pin or box joint to be a bit proud. The idea is to set the marking gauge to the thickness of the piece then transfer that depth to the workpiece.



There's another way to do this more quickly and still as accurately on the PantoRouter®.

Step 1 - Clamp the workpiece far enough forward of the table that your bit will clear, then bump the bit gently to the front of your workpiece.

Step 2 - Hold the bit against the workpiece, then move the back depth stop forward to the depth gauge and lock the lever.

Step 3 - Squeeze a sample of the workpiece between the depth gauge and the front stop then lock the lever.

Your bit will plunge only as deep as the thickness of the workpiece. If you want to make the cut a little proud, you can add some space at this step. This is the one operation on the PantoRouter® that is not 2:1, so add only as much as you want the joint to be proud.

Tip: Wrap a piece of blue tape around the sample board before squeezing in the depth stop to make the joint fit slightly proud. See photo on page: 26

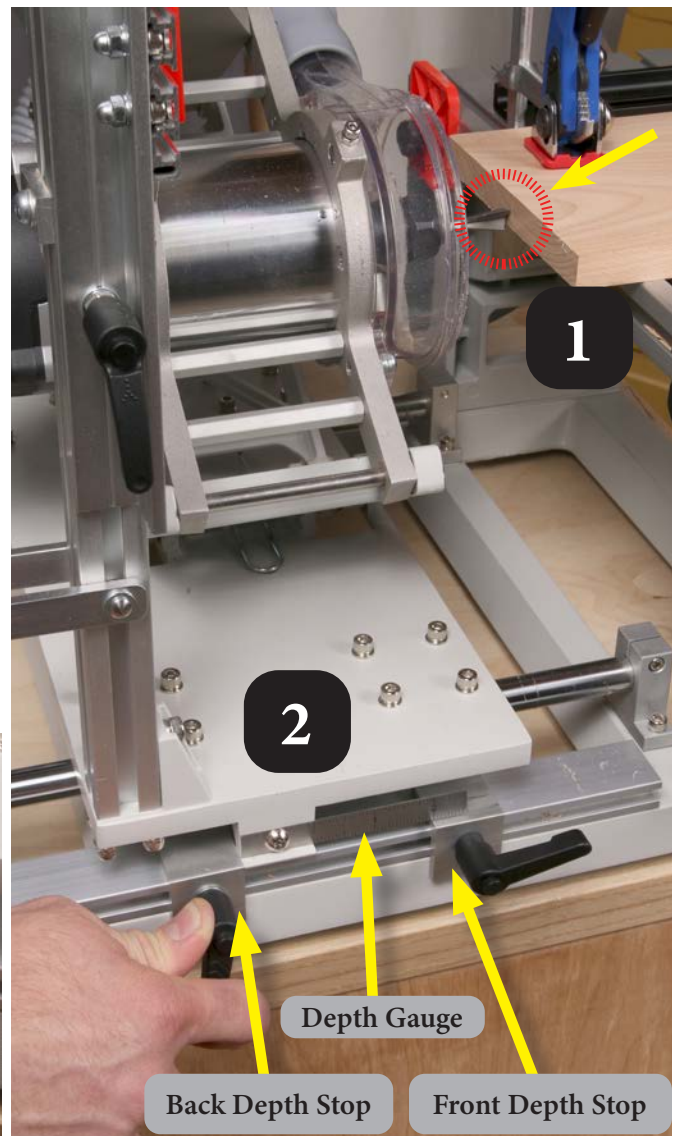

Check your clearance. Adjust the height of the template so at least half the bit clears the bottom of the workpiece before the bearing exits or bottoms out in the slot. Make sure the router doesn't hit the bottom of the templates and adjust so the guide bearing reaches all slots. With thicker stock, a maximum of seven template segments should be possible.

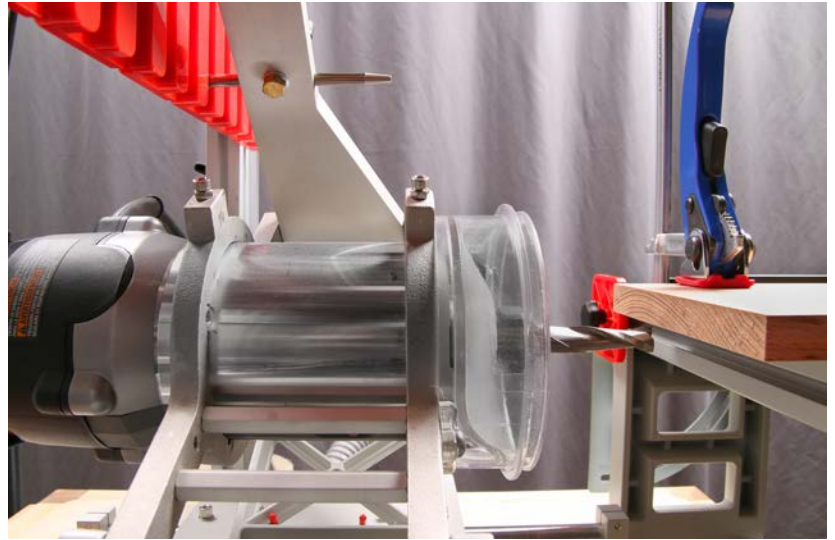

Cut the first side. You can cut a stack of parts at this point. Note how the bearing goes over the top of the templates for 1/2" box joints.

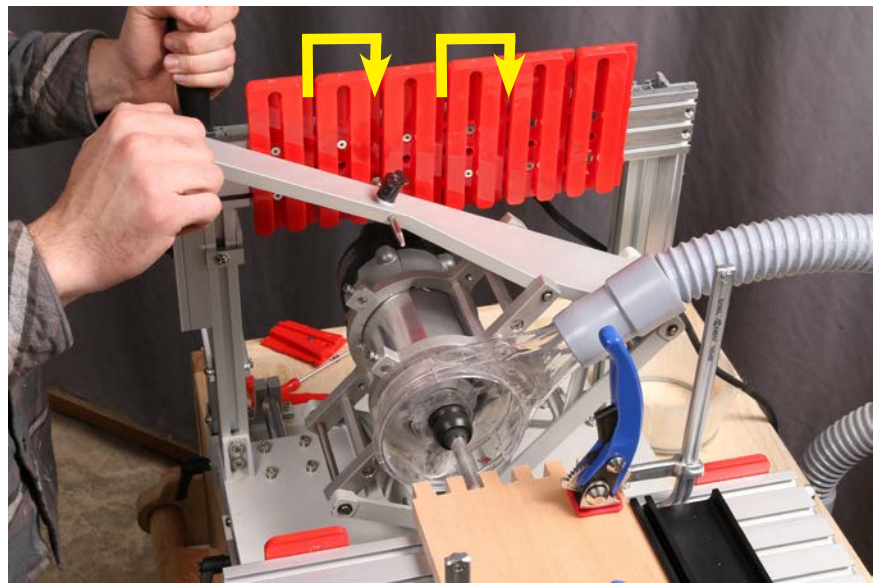

For 1/4" box joints you'll cut up from the bottom using each of the slots.

Tip: To get tighter box joints, "trace" only one side of the template. Use a light touch and don't go back over the cut. Routing is subtractive so every pass of the bit over the wood will remove slightly more material. Generally, whatever you do to any one cut should be done to all to keep them consistent.



Another dust-free process. Paired with a powerful vac or dust extractor, the PantoRouter's dust extractor system grabs every chip.



Measure the bit with dial calipers and rip or plane a spacer to the exact same width. The spacer goes between the workpiece and the fence, offsetting this half of the joint so the edges of the workpieces will line up.

(The aluminum fence shown to the right is an older model. The current version is black and no longer needs the round knob to stay square.)



Cut with confidence. Now you can cut stacks of boards for the other half of the joint, knowing the fit will be perfect.

Note: the finial on the top of this box was cut using a dovetail bit and a Dowel Template as described in the next section.



Dowel Templates

These seemingly simple templates are incredibly versatile and have many applications in the shop. Dowels can be cut from the same wood as your workpiece and used as floating dowels (traditional method) or as integral dowels or round tenons. The dowel templates use the 10mm guide bearing on the inside to make the dowel mortise, hole or pocket, and the same bit and guide bearing sizes as our mortise and tenon templates for the integral dowels or round tenons.



Locating the Dowel Templates

Unlike our other templates, the dowel templates do not have a centering hole however there are still several methods to accurately locate or center the dowel templates on the template holder.

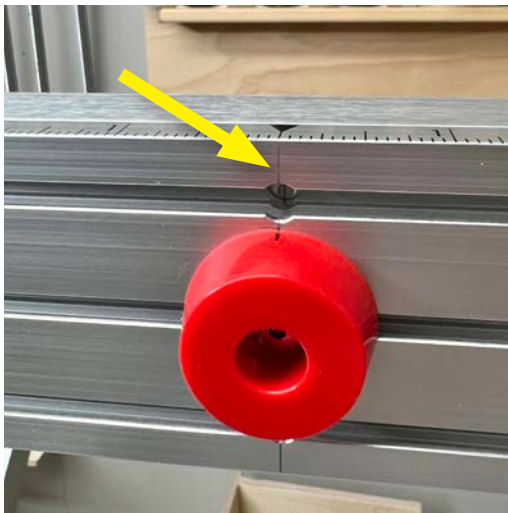

Centering the dowel template on the template holder is easy, simply align the indent on the top of the template with the centerline of the template holder. Note: the indent has been colored in with a marker for visibility.

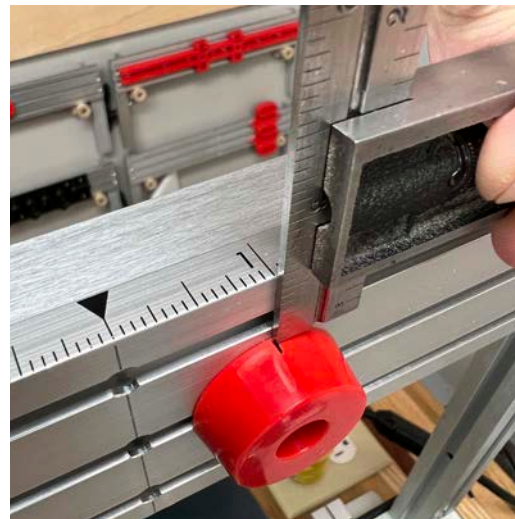

To locate the dowel templates on the template holder off-center or in a spaced array, use a small square to align the indent to the centering scale on the top edge of the template holder.

Tip: you can carry the lines on the top of the template holder down onto the face with a pencil to use for alignment.

Another method for accurately locating the dowel templates is to use the split shaft centering jig, the 10mm guide bearing, and the centering bar.

Slide the dowel templates onto the template holder and partially tighten the mounting screw leaving it just loose enough for the template to be able to move side to side. Place the 10mm guide bearing in the inside of the dowel template. With the template holder lever knobs loose, rest the flat face of the split shaft centering jig on the surface of the table and align the pointer to the desired mark on the centering bar, the dowel template will slide to the corresponding location. Hold the template in place with one hand and slide the guide bearing out with the other hand and then tighten the screw the rest of the way.

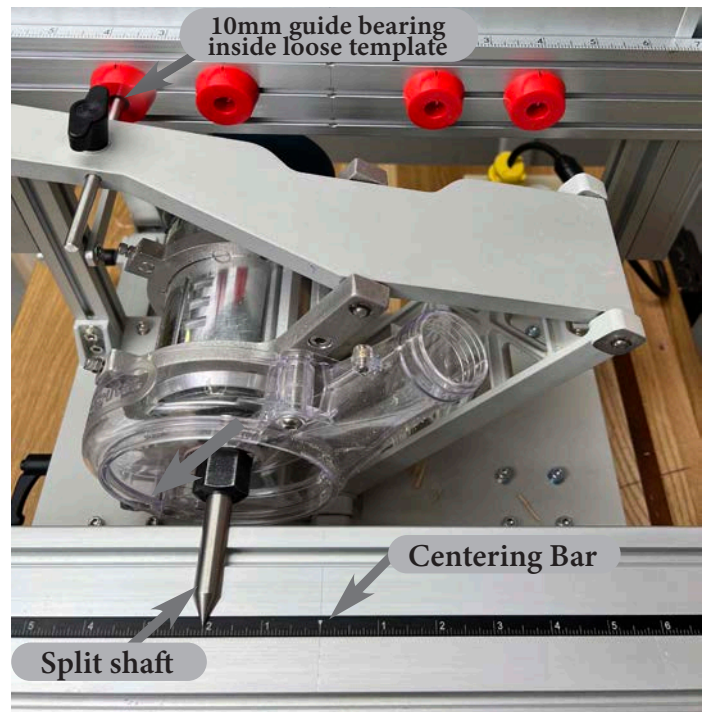

Joinery with Dowels

There are many applications for the dowel templates including mitered frames, horizontal boring, and wedged round through-tenons.



Horizontally bore holes in each of the mitered faces to be joined together

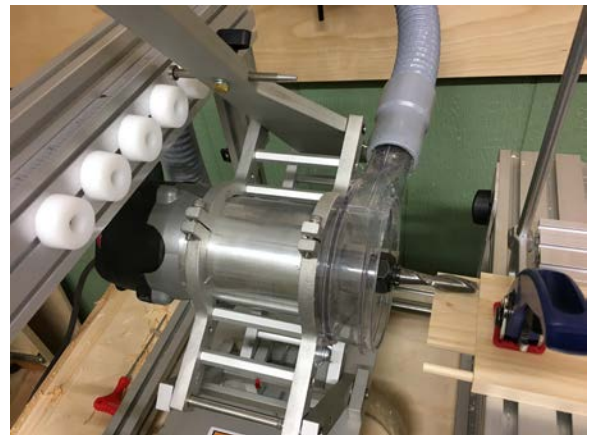

Cut dowels out of a spare piece of wood with the dowels running parallel with the grain



Cut the dowels free with a hand saw

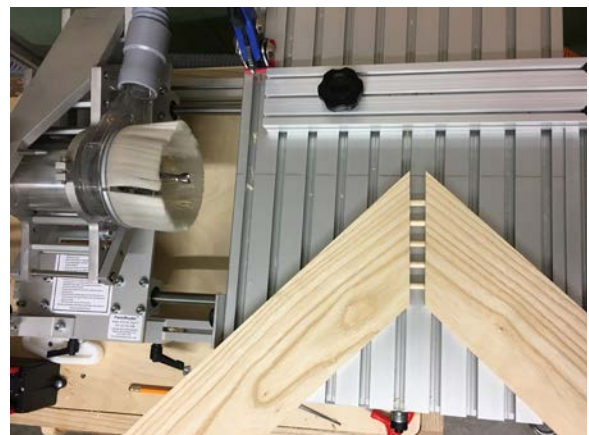

Assemble the joint using the floating dowels for alignment and strength

Perfect Fit for Round Tenons

Round through tenons can add a nice decorative detail to a piece and can be a great choice when you might need to rotate the orientation of a piece when the mortise and tenon are assembled. Add a contrasting wedge for an accent and a perfectly tight joint.



Drill a hole in a piece of scrap wood using a Forstner bit in your drill press



Cut the round tenon in the end of your workpiece starting high on the taper of the dowel template



Use the test block to check the fit while leaving your workpiece clamped in place



Adjust the guide bearing down the template to sneak up on a perfect fit



Once you have found the perfect fit, cut all of the tenons



Locating round tenons on other parts such as the seat of this stool is simple. Using the Same Forstner bit from before, drill a hole in a scrap piece of wood and place some double-stick tape on the face.

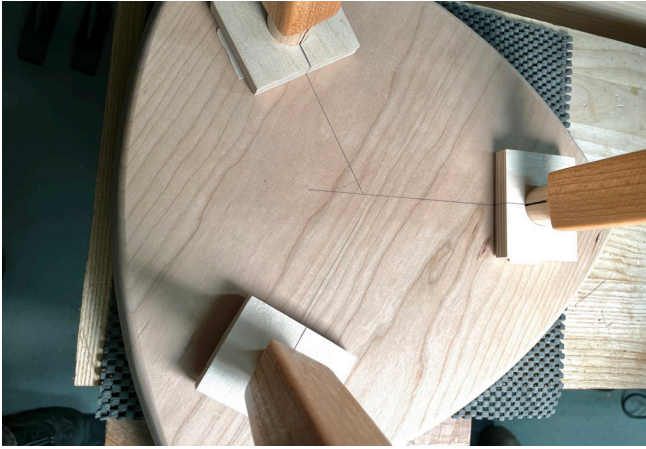

Slide the drilling guides onto the round tenons. Place the tenons in the desired location, then simply slide them down the tenon until the double stick tape contacts the mating piece.

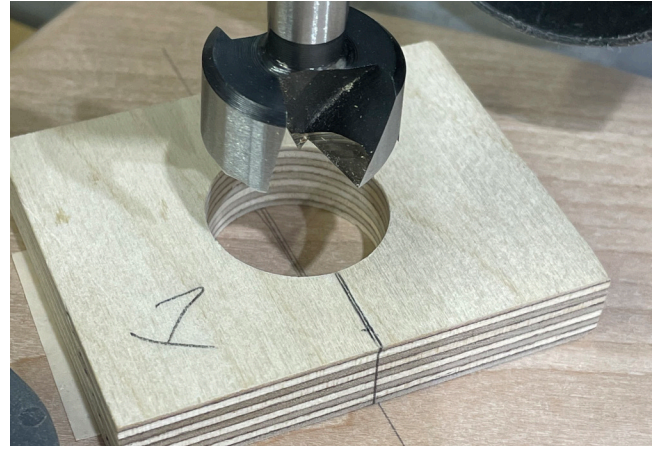

The plywood drilling guides make locating the Forstner bit easy, no measuring or math necessary.



The plywood drilling guides make locating the Forstner bit easy, no measuring or math necessary.



The end result is a strong and beautiful joint that will last a lifetime!

Not Just For Dowels. Try using the dowel template with different profile bits to make finials or pulls. This shape was cut using a large dovetail bit.



Specialty Templates and Accessories

Same Bit and Guide Bearing Inside and Out. The Diamond and Bow Tie templates use the same 10mm guide bearing and 3/8" bit for the mortise and tenon.

Diamond

Finished diamond shaped mortise and tenon is about 3/4" X 2-1/2"



Diamond shown with a wedge and dowel adornment. See the video on our website about making Krenov-style sawhorses to see how we did this.

Bow Tie

Finished bow tie mortise and tenon is about 3/4" X 2-1/2"

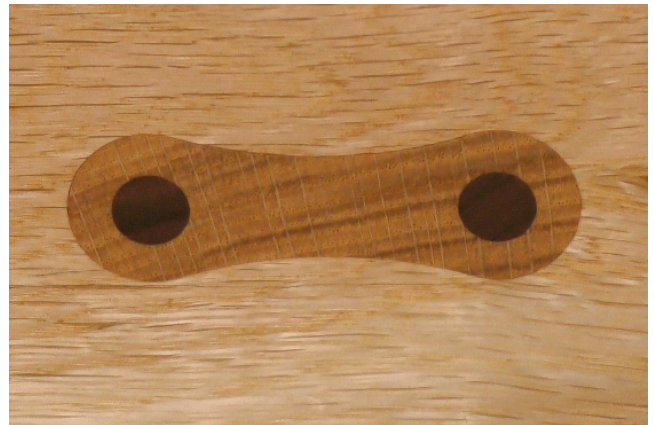

Bow Tie shown with round plugs made with our dowel templates.

Triple Mortise and Tenon

The triple mortise and tenon joint is intended for joining wider and thicker boards such as construction lumber on edge as seen in the photo below. The three horizontal tenons instead of one larger vertical tenon is an ideal choice because it leaves more continuous grain and has more glue surface area. The tenons are 3/8" X 7/8" and are spaced approximately 7/8" on center.



Calibrate the Template Holder in Under 3-Minutes

Alignment of the template to the pantograph and table is critical for accurate joinery. The template holder must be perfectly aligned to the frame and must slide freely on the posts. Adjusting it is quick and easy using the following method.

1. Move the operator's side slider so it is flush with the top of the template holder support post then lock the slider with the lever knob. Don't worry about anything else at this point, just the slider and the top of the operator's side template holder support post. See diagram on page: 45 for parts identification.
2. Keep the operator's side slider locked in place and loosen all four acorn nuts that hold the template holder to the sliders on both sides.
3. Align the slider opposite the operator to the top of the template holder support post and lock the lever knob. Both sliders should now be flush with the tops of the template holder support posts and the template holder should be slightly loose.
4. Align the template holder to the top of both template holder support posts on both sides then tighten the four acorn nuts with an 8mm or 5/16" wrench or nut driver.
5. Double check template holder alignment on both sides.
6. The template holder should now slide up and down freely and it should stay aligned to the template holder support frame. It's a good idea to periodically check the template holder alignment by touch or using a straight-edge to make sure it's still accurate.

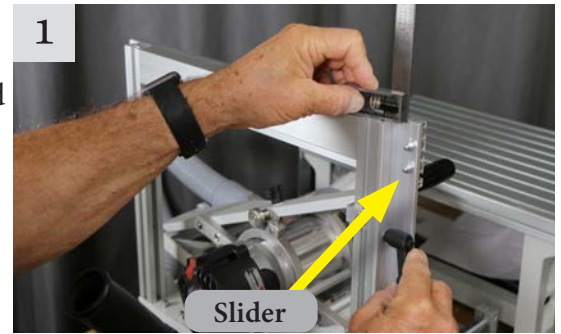

Segmented Mortise and Tenon Templates for the Pantorouter®

Mortise Bit Size Guide Bearing	1/8" M&T	1/4" M&T	5/16" M&T	3/8" M&T	1/2" M&T	3/4" M&T	1" M&T	Segment Combinations		
	6mm	10mm	12mm	15mm	22mm	35mm	48mm	All tenons use the 1/2" bit and guide bearings listed to left		
Mortise and Tenon Width (Rounded to 1/16")	3/4	7/8	15/16	1	1 1/8	1 3/8	1 5/8	●	●	Circle marked round-end pieces only
	1	1 1/8	1 3/16	1 1/4	1 3/8	1 5/8	1 7/8	▲	▲	Triangle marked round-end pieces only
	1 1/4	1 3/8	1 7/16	1 1/2	1 5/8	1 7/8	2 1/8	●	●	End pieces with segments of various combinations
	1 1/2	1 5/8	1 11/16	1 3/4	1 7/8	2 1/8	2 3/8	▲	▲	
	1 3/4	1 7/8	1 15/16	2	2 1/8	2 3/8	2 5/8	●	●	
	2	2 1/8	2 3/16	2 1/4	2 3/8	2 5/8	2 7/8	▲	▲	
	2 1/4	2 3/8	2 7/16	2 1/2	2 5/8	2 7/8	3 1/8	●	●	
	2 1/2	2 5/8	2 11/16	2 3/4	2 7/8	3 1/8	3 3/8	▲	▲	
	2 3/4	2 7/8	2 15/16	3	3 1/8	3 3/8	3 5/8	●	●	
	3	3 1/8	3 3/16	3 1/4	3 1/2	3 3/8	3 7/8	▲	▲	
	3 1/4	3 3/8	3 7/16	3 1/2	3 5/8	3 7/8	4 1/8	●	●	
	3 1/2	3 5/8	3 11/16	3 3/4	3 7/8	4 1/8	4 3/8	▲	▲	
	3 3/4	3 7/8	3 15/16	4	4 1/8	4 3/8	4 5/8	●	●	
	4	4 1/8	4 3/16	4 1/4	4 1/2	4 3/8	4 5/8	▲	▲	
	4 1/4	4 3/8	4 7/16	4 1/2	4 5/8	4 7/8	5 1/8	●	●	
	4 1/2	4 5/8	4 11/16	4 3/4	4 7/8	5 1/8	5 3/8	▲	▲	
	4 3/4	4 7/8	4 15/16	5	5 1/8	5 3/8	5 5/8	●	●	
	5	5 1/8	5 3/16	5 1/4	5 1/2	5 3/8	5 7/8	▲	▲	
	5 1/4	5 3/8	5 7/16	5 1/2	5 5/8	5 7/8	6 1/8	●	●	
	5 1/2	5 5/8	5 11/16	5 3/4	5 7/8	6 1/8	6 3/8	▲	▲	
	5 3/4	5 7/8	5 15/16	6	6 1/8	6 3/8	6 5/8	●	●	
	6	6 1/8	6 3/16	6 1/4	6 1/2	6 3/8	6 5/8	▲	▲	

Mortise Bit Size Guide Bearing	1/8" M&T	1/4" M&T	5/16" M&T	3/8" M&T	1/2" M&T	3/4" M&T	1" M&T	Segment Combinations		
	6mm	10mm	12mm	15mm	22mm	35mm	48mm	All tenons use the 1/2" bit and guide bearings listed to left		
Mortise and Tenon Width (Rounded to 1/16")	3/4	7/8	15/16	1	1 1/8	1 3/8	1 5/8	■	■	Square-end pieces only
	1 1/4	1 3/8	1 7/16	1 1/2	1 5/8	1 7/8	2 1/8	■	■	End pieces with segments of various combinations
	1 3/4	1 7/8	1 15/16	2	2 1/8	2 3/8	2 5/8	■	■	
	2 1/4	2 3/8	2 7/16	2 1/2	2 5/8	2 7/8	3 1/8	■	■	
	2 3/4	2 7/8	2 15/16	3	3 1/8	3 3/8	3 5/8	■	■	
	3 1/4	3 3/8	3 7/16	3 1/2	3 5/8	3 7/8	4 1/8	■	■	
	3 3/4	3 7/8	3 15/16	4	4 1/8	4 3/8	4 5/8	■	■	
	4 1/4	4 3/8	4 7/16	4 1/2	4 5/8	4 7/8	5 1/8	■	■	
	4 1/2	4 5/8	4 11/16	5	5 1/8	5 3/8	5 5/8	■	■	
	4 3/4	4 7/8	4 15/16	5 1/2	5 3/8	5 7/8	6 1/8	■	■	
	5	5 1/8	5 3/16	5 1/4	5 1/2	5 3/8	5 5/8	■	■	
	5 1/4	5 3/8	5 7/16	5 1/2	5 5/8	5 7/8	6 1/8	■	■	
	5 1/2	5 5/8	5 11/16	5 3/4	5 7/8	6 1/8	6 3/8	■	■	
	5 3/4	5 7/8	5 15/16	6	6 1/8	6 3/8	6 5/8	■	■	
	6	6 1/8	6 3/16	6 1/4	6 1/2	6 3/8	6 5/8	■	■	

*Note: On the 5 1/2" and 5 3/4" round-end M&T and the 5 1/2" square end M&T, there is not a centering hole. Align the ends to be equidistant from center using a square for these sizes.

● Indicates the round-end pieces with the circle mark. Using these together makes a 1" wide M&T x 3/8" thick (other sizes according to the chart above)

▲ Indicates the round-end pieces with the triangle mark. Using these together makes a 1 1/4" M&T x 3/8" thick (other sizes according to the chart above)

■ Indicates the square-end pieces. Using these together makes a 1" M&T x 3/8" thick. The tenon will have square ends.

The square-end templates do not have steps in the mortise slot since these will always be through M&T and the ends of the mortise will need to be squared with a chisel

Get the most out of your PantoRouter® with Jigs and Fixtures

Auxiliary Table

To learn more about when and how to use the Auxiliary table, scan the code and watch this video.

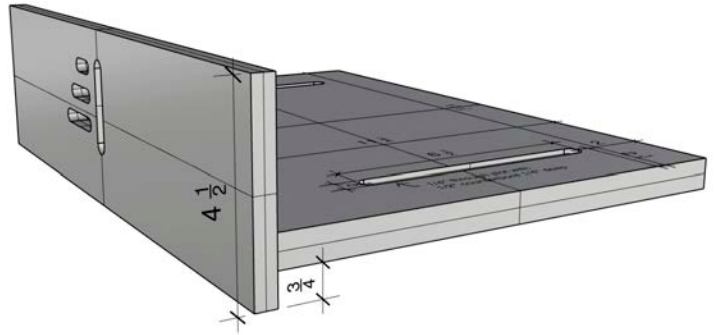
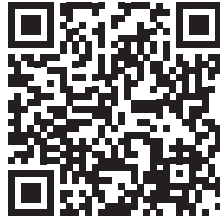

Build your own Auxiliary Table by downloading the free plans here:



Vertical Clamping Jig

To learn more about when and how to use the Vertical Clamping Jig, scan the code and watch this video.

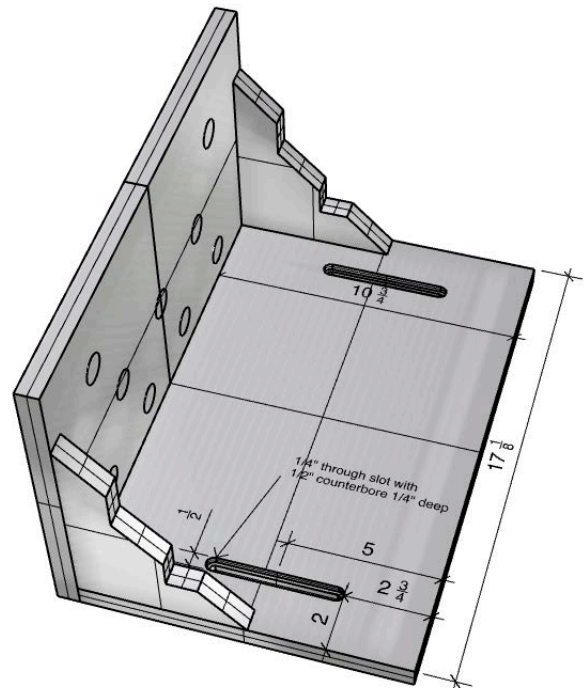

Build your own Vertical Clamping Jig by downloading the free plans here:



Basic Components of the PantoRouter®

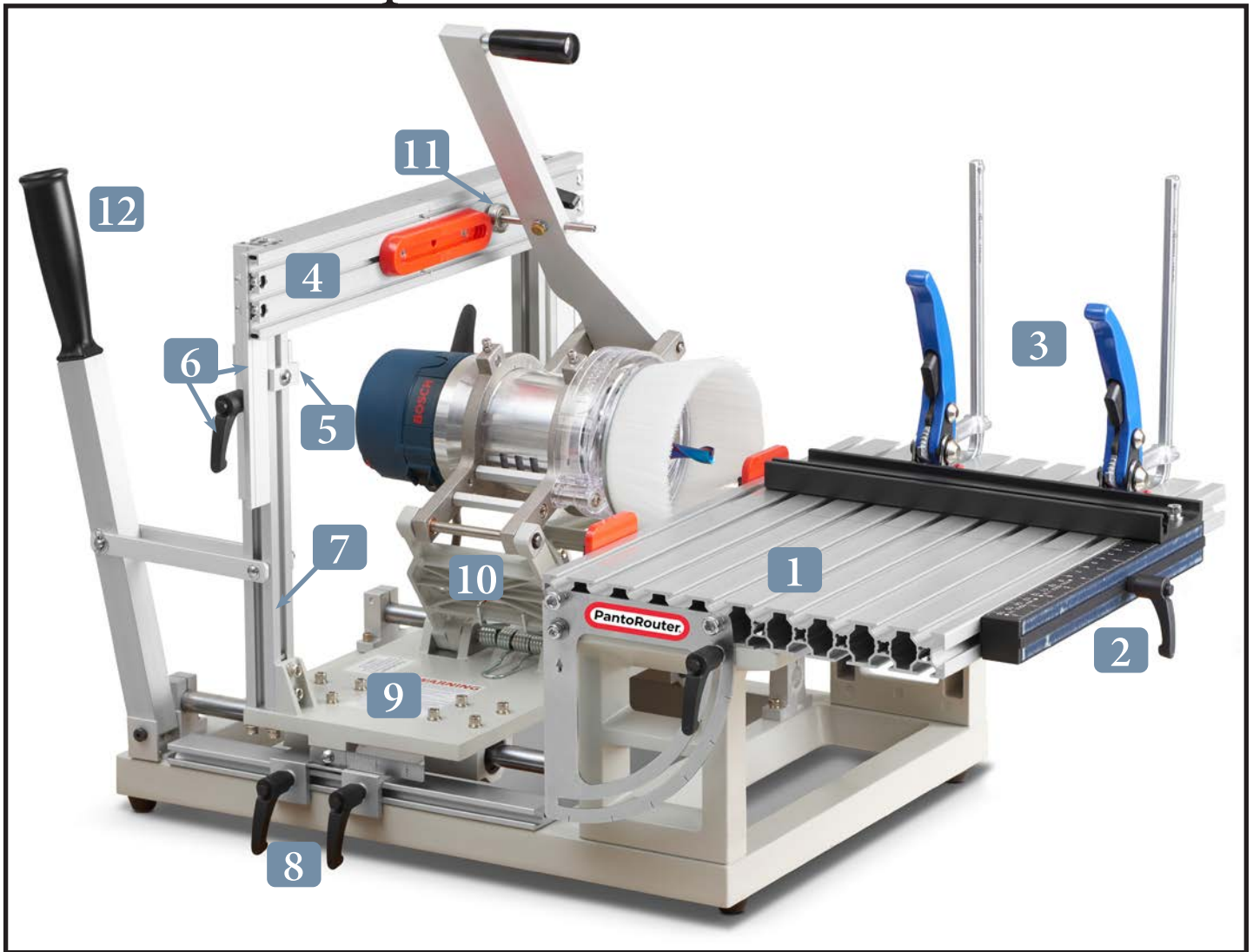

1. Table
2. Centering Scale Fence
3. T-Slot Lever Clamps
4. Template Holder With Template
5. Thickness Gauge
6. Template Holder Slider and Locking Lever
7. Template Holder Support Post
8. Depth Stops - front and back
9. Pantograph Carriage
10. Pantograph
11. Guide Bearing
12. Plunge Lever

See the assembly guide for more detailed photos and descriptions of the PantoRouter® components

YouTube Video Links

Scan the code with your phone or tablet to go directly to these videos.



Dialing-In the
PantoRouter
Joinery Machine



Segmented
Mortise and Tenon



Slot Mortise



Variably Spaced
Dovetails



Dowel Templates



Guide Bearing
Collars



Angled Tenons



Intersecting Mortise
and Tenon



Index a Series of
Mortises



Trim Box Joints
with a Flush Trim
Bit



Krenov-Style
Sawhorses



Box Joints of Any
Size

Patents: 10,639,754 11,351,641 10,016,868 11,517,988 11,524,376 11,524,375 18832971.7-EPO
And others foreign and domestic pending and applied for.

PantoRouter

www.PantoRouter.com

Info@PantoRouter.com

+1-877-333-7150

Copyright January 2023 - WoodCraft Solutions LLC